

TITLE 92: TRANSPORTATION

CHAPTER I: DEPARTMENT OF TRANSPORTATION

SUBCHAPTER b: AERONAUTICS

PART 14
AVIATION SAFETY

SUBPART A: GENERAL PROVISIONS

Section

- 14.100 Purpose and Applicability
- 14.105 Definitions
- 14.110 Operation Without Certificate of Approval Unlawful
- 14.115 Application Process for Original Certificate of Approval
- 14.120 Transfer/Modification/Rescission of Certificate of Approval
- 14.130 Waivers

SUBPART B: AIRCRAFT REGISTRATION

Section

- 14.200 Registration of Aircraft
- 14.210 Time and Manner of Registration
- 14.220 Exhibition of Certificates and Decal
- 14.230 Exceptions to Registration Requirements

SUBPART C: AIRMAN REGISTRATION

Section

- 14.300 Registration of Airman
- 14.310 Time and Manner of Registration
- 14.320 Exhibition of Certificates
- 14.330 Exceptions to Registration Requirements

SUBPART D: AIR SAFETY

Section

- 14.400 Applicability
- 14.410 Responsibility and Authority of Pilot
- 14.420 Use of Liquor, Narcotics and Drugs
- 14.430 Transportation of Explosives, Dangerous Articles or Illegal Substances
- 14.440 Dropping Objects from Aircraft
- 14.450 Fuel Requirements for Flight in VFR Conditions
- 14.460 Fuel Requirements for Flight in IFR Conditions

SUBPART E: AIRPORTS

Section

- 14.500 Airport Classification
- 14.510 Application for Certificate of Approval
- 14.520 Design and Layout Requirements
- 14.530 Obstructions
- 14.540 Airport Marking
- 14.550 Facilities
- 14.560 Responsibility of a Public-Use Airport Certificate Holder
- 14.570 Responsibility of a Private-Use Airport Certificate Holder
- 14.580 Restrictions on Use

SUBPART F: AIRPORTS FOR NON-CONVENTIONAL AIRCRAFT

Section

- 14.600 Airport Classification
- 14.610 Application for Certificate of Approval
- 14.620 Public-Use of Airports for Non-Conventional Aircraft
- 14.630 Private-Use of Airports for Non-Conventional Aircraft
- 14.640 Restrictions on Use

SUBPART G: RESTRICTED LANDING AREAS

Section

- 14.700 Restricted Landing Area Classification
- 14.710 Application for Certificate of Approval
- 14.720 Design and Layout Requirements
- 14.730 Obstructions
- 14.740 Facilities
- 14.750 Responsibility of a Restricted Landing Area Certificate Holder
- 14.760 Fly-In Events, Prevention of Accidents Due to Overcrowding of Landing Areas
- 14.770 Restrictions on Use

SUBPART H: HELIPORTS/VERTIPOINTS

Section

- 14.800 Heliport/Vertiport Classification
- 14.810 Application for Certificate of Approval
- 14.820 Design and Layout Requirements
- 14.830 Obstructions
- 14.840 Heliport Marking
- 14.850 Facilities
- 14.860 Responsibility of a Public-Use Heliport Certificate Holder
- 14.870 Responsibility of a Private-Use Heliport, Restricted Landing Area Heliport, and Hospital Heliport Certificate Holder
- 14.880 Restrictions on Use

SUBPART I: SPECIAL PURPOSE AIRCRAFT

Section	
14.900	Special Purpose Aircraft Designation
14.910	Registration of Special Purpose Aircraft
14.920	Exemption from Registration
14.930	Compliance with Aircraft Registration
14.940	Liability
14.950	Special Purpose Aircraft Operations
14.960	Saving Clause

SUBPART J: ULTRALIGHTS AND ULTRALIGHT TRAINERS

Section	
14.1000	Registration for Ultralights and Ultralight Trainers
14.1010	Liability
14.1020	Ultralight/Ultralight Trainer Operations
14.1030	Saving Clause

SUBPART K: PRACTICE AND PROCEDURE

Section	
14.1100	Purpose and Applicability
14.1105	Filing of Documents
14.1110	Formal Specifications
14.1115	Copies
14.1120	Verification of Documents
14.1125	Identity of Filer
14.1130	Amendment of Documents
14.1135	Responsive Documents
14.1140	Service of Documents
14.1145	Appearances
14.1150	Informal Participation in Hearing Cases
14.1155	Formal Participation
14.1160	Computation of Time
14.1165	Extensions of Time
14.1170	Motions
14.1175	Answers to Motions
14.1180	Subpoenas
14.1185	Administrative Law Judge (ALJ)
14.1190	Hearings
14.1195	Petition for Rehearing
14.1196	Administrative Review

14.APPENDIX A Airport Standards

14.ILLUSTRATION A	Airports (Public- or Private-Use) Minimum Dimensional Standards
14.ILLUSTRATION B	Airports (Public- or Private-Use) Minimum Separation & Gradient Standards
14.ILLUSTRATION C	Ultralight/STOL Airports (Public- or Private-Use) Minimum Dimensional Standards
14.ILLUSTRATION D	Ultralight/STOL Airports (Public- or Private-Use) Minimum Separation & Gradient Standards
14.ILLUSTRATION E	Airports (Public- or Private-Use) Line of Sight
14.ILLUSTRATION F	Airports (Public- or Private-Use) Visual Runway Markings
14.ILLUSTRATION G	Airports (Public- or Private-Use) Numerals Detail
14.ILLUSTRATION H	Airports with Non-Standard Traffic Patterns (Public- or Private-Use) Segmented Circle Detail
14.ILLUSTRATION I	Airports (Public- or Private-Use) Displaced Threshold Markings
14.ILLUSTRATION J	Airports (Public- or Private-Use) Closed Airport and Closed Runway Marker
14.APPENDIX B	Airport Facility Requirements and Restrictions on Use
14.TABLE A	Facility Requirements
14.TABLE B	Restrictions on Use
14.APPENDIX C	Airports for Non-Conventional Aircraft Standards
14.ILLUSTRATION A	Airports for Non-Conventional Aircraft Minimum Dimensional Standards
14.APPENDIX D	Airports for Non-Conventional Aircraft Restrictions on Use
14.TABLE A	Restrictions on Use
14.APPENDIX E	Restricted Landing Areas Standards
14.ILLUSTRATION A	Restricted Landing Areas Minimum Dimensional Standards
14.ILLUSTRATION B	Restricted Landing Areas Minimum Separation & Gradient Standards
14.ILLUSTRATION C	Restricted Landing Areas Displaced Threshold Markings
14.ILLUSTRATION D	Restricted Landing Areas Closed RLA & Closed Runway Marker
14.APPENDIX F	Restricted Landing Areas Restrictions on Use
14.TABLE A	Restrictions on Use
14.APPENDIX G	Heliport/Vertiport Standards
14.ILLUSTRATION A	Public- or Private-Use Heliport/Vertiport Minimum Dimensional Standards
14.ILLUSTRATION B	Restricted Landing Area Heliport Minimum Dimensional Standards
14.ILLUSTRATION C	Hospital Heliport Minimum Dimensional Standards
14.ILLUSTRATION D	Heliports Sample Obstruction Clearance Slope Calculations

14.ILLUSTRATION E	Public or Private Heliport (Non-Hospital) Typical Heliport Marking
14.ILLUSTRATION F	Rooftop or Elevated Hospital Heliport Typical Heliport Marking
14.ILLUSTRATION G	Surface Hospital Heliport Typical Heliport Marking
14.APPENDIX H	Heliport/Vertiport Standards, Facility Requirements and Restrictions on Use
14.TABLE A	Heliport Standards
14.TABLE B	Facility Requirements
14.TABLE C	Restrictions on Use

AUTHORITY: Implementing and authorized by the Illinois Aeronautics Act [620 ILCS 5].

SOURCE: Part repealed at 28 Ill. Reg. 2298, effective January 26, 2004; New Part adopted at 28 Ill. Reg. 2302, effective January 26, 2004.

For purposes of this Part, the singular shall include the plural, the plural the singular and the masculine the feminine.

Section 14.100 Purpose and Applicability

- a) This Part sets forth the standards for the creation, classification, modification, operation and certification of public and private aircraft landing areas, and it also regulates airmen and aircraft.
- b) This Part applies to all manned aircraft, including those not required to be registered with or approved by the Federal Aviation Administration (the FAA).
- c) The Department of Transportation (the Department) will apply and interpret this Part, whenever practicable, in a manner consistent with the federal government and with other states.
- d) All forms referenced in this Part may be obtained by contacting the Division of Aeronautics (the Division) by phone at 217-785-8516, by writing to or visiting the Division at 1 Langhorne Bond Drive, Capital Airport, Springfield, IL 62707, by e-mail at Aero@nt.dot.state.il.us or by accessing the Division's web site at www.dot.state.il.us.

Section 14.105 Definitions

For purposes of this Part, the words, terms and phrases listed shall have the meanings ascribed to them as follows:

"Act" means the Illinois Aeronautics Act [620 ILCS 5].

"Administrator" as used, except as otherwise specifically provided in 14 CFR 1, effective October 1, 2002, shall mean the Administrator of the FAA or an officer or employee of the Administrator of the FAA designated by him in writing for the purpose specified in that designation.

"Aerobatic Flight" means maneuvers intentionally performed by an aircraft involving an abrupt change in attitude or an abnormal attitude or acceleration not necessary for normal flight.

"Aeronautics" means transportation by aircraft; the operation, construction, repair or maintenance of aircraft, aircraft power plants and accessories, including the repair, packing and maintenance of parachutes; the design, establishment, construction, extension, operation, improvement, repair or maintenance of airports, restricted landing areas, or other air navigation facilities and air instruction. (See Section 2 of the Act.)

"Air Navigation" means the operation or navigation of aircraft in the airspace over this State, or upon any airport or restricted landing area within this State. Air Navigation does not mean the taxiing of aircraft on the ground for repositioning or maintenance purposes. (See Section 10 of the Act.)

"Air Navigation Facility" means any facility other than one owned or controlled by the federal government, used in, available for use in, or designed for use in, aid of air navigation, including airports, heliports/vertiports, restricted landing areas, and any structures, mechanisms, lights, beacons, marks, communicating systems, or other instruments or devices used or useful as an aid, or constituting an advantage or convenience, to the safe takeoff, navigation and landing of aircraft, or the safe and efficient operation or maintenance of an airport, heliport/vertiport, or restricted landing area, and any combination of any or all such facilities. (See Section 9 of the Act.)

"Aircraft" means any device used or designed to carry humans in flight as specified by the Division in this Part. All devices required to be licensed as "aircraft" by the FAA on the effective date of this Part are "aircraft." The Division has, by Subpart J of this Part, specified the extent to which aircraft not

required to be licensed by the FAA are subject to the provisions of this Part. (See Section 3 of the Act.)

"Airman" means any individual who operates or is licensed to operate an aircraft in flight. Airman as used in this Part also means pilot. (See Section 12 of the Act.)

"Airplane" means an engine-driven fixed-wing aircraft heavier than air, that is supported in flight by the dynamic reaction of the air against its wings (14 CFR 1, effective October 1, 2002.)

"Airport" means any area of land, water or both, except a restricted landing area, that is designed for the landing and takeoff of aircraft, whether or not facilities are provided for the shelter, servicing, or repair of aircraft, or for receiving or discharging passengers or cargo; and, all appurtenant areas used or suitable for airport buildings or other airport facilities, and all appurtenant rights-of-way, whether established before or after the effective date of this Part. (Various airport classifications may be found in Subpart E, Subpart F and Subpart H of this Part.) (See Section 6 of the Act.)

"Airport Hazard" means any structure, object of natural growth, or use of land that obstructs the airspace required for the flight of aircraft in landing or takeoff at any airport or restricted landing area or is otherwise hazardous to the landing or takeoff of aircraft. (See Section 22 of the Act.)

"Applicant" means, but is not limited to, the person, trust, company, governmental body, corporation, limited liability company or association to whom a Certificate of Approval may be issued.

"Certificate Holder" means, but is not limited to, the person, trust, company, governmental body, corporation, limited liability company or association to whom a Certificate of Approval has been issued.

"Certificate of Approval" means a certificate issued by the Division approving the operation of an airport or restricted landing area as specified by the Division.

"Certificate of Registration" means a certificate issued by the Division indicating that, for purposes of Subpart B of this Part, an individual has registered his FAA license, certificate or permit with the Division for his aircraft; and, for purposes of Subpart C of this Part, means a certificate issued by the Division indicating that an individual has registered his current and appropriate FAA issued pilot certificate with the Division.

"Civil Aircraft" means any aircraft other than a public aircraft. (See Section 5 of the Act.)

"Department" means the Illinois Department of Transportation.

"Design Helicopter/VTOL Aircraft" means a generic rotorcraft/vertical takeoff or landing (VTOL) aircraft that reflects the maximum size of all helicopters/VTOL aircraft expected to operate at the heliport/vertiport.

"Displaced Threshold" means a threshold that has been displaced to provide for obstruction clearance. The portion of runway behind a displaced threshold may be available for takeoffs in either direction or landings from the opposite direction.

"Division" means the Illinois Department of Transportation, Division of Aeronautics, 1 Langhorne Bond Drive, Capital Airport, Springfield, IL 62707-8415.

"FAA" means the Federal Aviation Administration.

"Final Approach and Takeoff Area" or "FATO" means a defined object-free area over which the final phase of the approach to a hover, or a landing, is completed and from which the takeoff is initiated.

"Flight Instruction" means the imparting of aeronautical knowledge by a FAA authorized flight instructor specifically involving the actual flight of an aircraft, or by a FAA sanctioned flight instructor involving the actual flight of an Ultralight training aircraft.

"Fly-In Event" means any congregation of aircraft, other than based aircraft, in excess of six aircraft.

"Heliport/Vertiport" means a generic reference to the area of land, water or structure used, or intended to be used, for the landing and takeoff of helicopters/VTOL aircraft, together with associated buildings and facilities.

"Helistop/Vertistop" means a minimally developed helicopter/VTOL aircraft facility for boarding and discharging passengers or cargo. The heliport/helistop, vertiport/vertistop relationship is comparable to a bus terminal - bus stop relationship with respect to the extent of services provided or expected.

"Hospital Heliport/Vertiport" means a heliport/vertiport limited to serving only helicopters/VTOL aircraft engaged in air ambulance, or hospital related functions.

"IFR" means instrument flight rules.

"Landing Strip" means a portion of the usable area within an airport boundary that either in its natural state or as a result of construction work is suitable for the landing and takeoff of aircraft.

"Modification" means any change to the Certificate of Approval as originally issued by the Division, including, but not limited to, extension or alteration of the airport or restricted landing area, change in ownership, change in classification or change in status.

"Municipality" means any county, city, village or town of this State and any other political subdivision, public corporation, authority, or district in this State, or any combination of two or more of the same that is or may be authorized by law to acquire, establish, construct, maintain, improve and operate airports and other air navigation facilities. (See Section 20 of the Act.)

"Notice" means a legal document prepared by the Division, to be published in a newspaper in the county in which the airport or restricted landing area sought to be established, altered or extended is, or is proposed to be located, indicating that the Division intends to enter an Order regarding the application for the proposed airport or restricted landing area, or the alteration or extension thereof. (See Section 60 of the Act.)

"Nuisance" means operating an aircraft in an annoying or vexatious manner.

"Operation of Aircraft or Operate Aircraft" means the use of aircraft for the purpose of air navigation, and includes the navigation or piloting of aircraft. Any person who causes or authorizes such use of aircraft, whether with or without the right of legal control (in the capacity of owner, lessee, or otherwise) of the aircraft, shall be deemed to be engaged in the operation of aircraft. Operation of aircraft does not mean ground movement for repositioning or maintenance purposes. (See Section 11 of the Act.)

"Order" means a legal document prepared by the Division, to be published in a newspaper in the county in which the airport or restricted landing area sought to be established, altered or extended is, or is proposed to be located, that may either grant or deny an application for a Certificate of Approval. If granted, the Order allows the applicant to begin construction of the proposed airport or restricted landing area, or the alteration or extension thereof. (See Section 60 of the Act.)

"Person" means, but is not limited to, any individual, firm, partnership, corporation, company, limited liability company, association, joint stock association, joint venture, public service corporation or body politic; and includes any trustee, receiver, assignee or other similar representative. (See Section 17 of the Act.)

"Pilot" means airman.

"Pilot-in-Command" means the person who has final authority and responsibility for the operation and safety of the flight; and, has been designated as pilot-in-command before or during the flight; and, holds the appropriate category, class and type rating, if appropriate, for the conduct of the flight.

"Private Use" means that an airport is not open to the general public. Use is limited to the Certificate Holder and any other users as authorized by the Certificate Holder.

"Public Aircraft" means an aircraft used exclusively in the service of any government or of any political subdivision thereof, including the government of any state, territory, or possession of the United States, or the District of Columbia, but not including any government aircraft engaged in carrying persons or property for commercial purposes. (See Section 4 of the Act.)

"Public Use" means that an airport is open to the general public.

"Restricted Landing Area (RLA)" means any area of land, water, or both that is used or is made available for the landing and takeoff of aircraft that is intended for private use. (See Section 8 of the Act.)

"Rotorcraft" means a heavier-than-air aircraft that depends principally for its support in flight on the lift generated by one or more rotors (14 CFR 1, effective October 1, 2002.)

"Runway" means the paved, hard surfaced or stabilized central portion of a landing strip.

"Runway Protection Zone" means a defined area off the end of a runway that is clear of incompatible objects and activities.

"Runway Safety Area (RSA)" means a defined surface surrounding the runway prepared or suitable for reducing the risk of damage to airplanes in the event of an undershoot, overshoot, or excursion from the runway.

"Sea Lane" means a water landing and departure surface.

"Seaplane" means all aircraft designed for water operations and includes amphibious aircraft when they are operating on water.

"Special Purpose Aircraft" means the following: manned balloons, lighter-than-air aircraft, seaplanes, sailplanes, gliders and other powerless aircraft, heavier-than-air aircraft, agricultural aircraft during the time used solely for agriculture applications, helicopters/VTOL aircraft, and any other aircraft as designated by the Division. Use and limitations provisions for special purpose aircraft are contained in Subpart I of this Part.

"State" or "this State" means the State of Illinois. (See Section 7 of the Act.)

"STOL" means short takeoff and landing.

"STOL Operation" means the operation of an aircraft, at some weight within its approved operating weight, in compliance with applicable federal STOL standards, characteristics and airworthiness.

"Stopway" means a defined rectangular surface beyond the end of a runway, prepared or suitable for use in lieu of a runway, to support an airplane without causing structural damage to the airplane during an aborted takeoff.

"Threshold" means the beginning of that portion of runway available for landing. In some instances the landing threshold may be displaced.

"TLOF" means Touch Down and Lift-off Area, commonly referred to as a helipad and normally centered in a Final Approach and Takeoff Area (FATO).

"Ultralight" means any aircraft intended to be used by a single occupant for recreation or sport purposes only, does not have an airworthiness certificate, weighs less than 155 pounds if non-powered, or if powered, weighs less than 254 pounds empty weight, excluding floats and safety devices which are intended for deployment in a potentially catastrophic situation, has fuel capacity not exceeding five U.S. gallons, is not capable of more than 55 knots calibrated air speed at full power in level flight and has a power-off stall speed that does not exceed 24 knots calibrated air speed.

"Ultralight Trainer" means any aircraft that does not have an airworthiness certificate, is used or intended to be used in the air for training Ultralight pilots, and meets the requirements for operating under an FAA approved Ultralight training exemption.

"Vertiport" means, for the purposes of this Part, a heliport.

"VFR" means visual flight rules.

"VTOL" means aircraft capable of vertical takeoff and landing operations.

"Wind Indicator" means tetrahedron, wind tee or wind cone (windsock).

Section 14.110 Operation Without Certificate of Approval Unlawful

It shall be unlawful for any municipality or other political subdivision, or officer or employee thereof, or for any person, company or association of persons to use or operate any airport or restricted landing area for which a Certificate of Approval has not been issued by the Division; provided, that no Certificate of Approval shall be required for an airport or restricted landing area which was in existence and approved by the Illinois Aeronautics Commission, whether or not being operated on or before July 1, 1945, and all representations, conditions and restrictions incidental to the latter have been fulfilled and complied with. (See Section 47 of the Act.)

Section 14.115 Application Process for Original Certificate of Approval

An applicant for an original Certificate of Approval for a new airport or RLA must complete the following process before a Certificate of Approval will be issued by the Division. All forms referenced in this Section may be obtained from the Division at the address noted in Section 14.100(d).

- a) The applicant must personally contact the Division either by phone at 217-785-8516, in writing at 1 Langhorne Bond Drive, Capital Airport, Springfield, IL 62707, or by e-mail at Aero@nt.dot.state.il.us to request an initial inspection of the site proposed to be used for the airport or RLA.
- b) The applicant must include proof of continuing property interests in, and authority to operate, the requested airport or RLA on the subject property as evidenced by:
 - 1) the approval of the property owner (i.e., a letter with the property owner's signature) if not the same as the applicant, or
 - 2) a copy of the deed or long-term lease.
- c) Division personnel will visit the proposed site, as early as Division priorities will allow, to determine if the minimum standards for the operation of an airport or RLA, as prescribed in either Section 14.510(a), 610(a), 710(a) or 810(a), can be achieved.
 - 1) After an initial inspection has been performed and the site is determined to be acceptable under this Part, an Application for Certificate of Approval form (Form AER 2059 for an airport or RLA or Form AER 2060 for a heliport) must be completed and signed, along with FAA Forms 7480-1 (Notice of Landing Area Proposal) and 7480-2 (Sketch), and the originals mailed or hand-delivered to the Division at the address noted in Section 14.100(d).
 - 2) If the proposed site is not acceptable, under this Part, Division personnel will advise the applicant as to what can be done to achieve an acceptable site (e.g., cut trees, clear brush) or suggest an alternative site.
- d) The Division will submit FAA Forms 7480-1 and 7480-2 to the FAA for an airspace determination. Once the Division has received a favorable airspace determination from the FAA (in approximately 30-60 days), the applicant will be notified in writing and the Division will proceed in processing the application for Certificate of Approval. If the FAA issues a non-favorable airspace

determination, the applicant will be notified in writing as to what criteria needs to be met to receive a favorable determination (e.g., pattern agreement with another airport or RLA, cut trees).

- e) The Division will publish a Notice in the local newspaper, within the county of the proposed site of the airport or RLA, indicating that the Division intends to publish an Order granting or denying a Certificate of Approval, with a copy simultaneously mailed to the applicant. All interested persons may, prior to the publication of the Order in the newspaper, file objections to or comments on the proposed Order by writing to the Division, at the address noted in Section 14.100(d), within 15 days after the date of publication of the Notice in the newspaper. The Division will consider any comments or opposition received within the 15-day period prior to making a decision to grant or deny a Certificate of Approval and prior to publishing the Order. (See Section 60 of the Act.)
- f) If no comments or opposition to the proposed airport or RLA are received by the Division within the 15-day period, the Division will publish an Order in the local newspaper, within the county of the proposed site of the airport or RLA approving the construction, with a copy simultaneously mailed to the applicant. The Order will include the terms and restrictions (e.g., number of based aircraft, restrictions on use) associated with the issuance of the Certificate of Approval, as well as providing information as to a completion date for construction and for the final inspection of the airport or RLA that must occur before the Certificate of Approval will be issued. (See Section 60 of the Act.)
- g) After the Order is published, interested persons may write or e-mail comments to the Division, or request a hearing in writing (see Subpart K), at the address noted in Section 14.100(d), as to the validity or reasonableness of the Order. Comments will be accepted for a 15-day period after publication of the Order in the local newspaper. Unless the Division finds that a hearing is necessary or that a longer period of time is appropriate, the Order will be effective 20 days after publication in the local newspaper. A Certificate of Approval may be issued anytime after the effective date of the Order. The Division will consider all comments received within the 15-day period prior to making a decision whether to grant or deny a Certificate of Approval. (See Section 60 of the Act.)
- h) After publication of the Order, if a hearing is requested, the Division will schedule it at the earliest date possible in the county seat of the county where the proposed airport or RLA is to be located. All interested persons will be notified in writing at least 10 days prior to the scheduled date of the hearing. After the hearing has been held, the Division will issue a Supplemental Order indicating the findings and conclusions of the hearing and whether the original Order will

stand or whether it will be modified. A copy of the Supplemental Order will be mailed to the applicant as well as to the person or persons requesting the hearing.

- i) The applicant will have 18 months from the effective date of the Order to complete construction of the airport or RLA. The applicant shall contact the Division in writing or by phone, as noted in Section 14.100(d), within 30 days after the completion of construction of the airport or RLA to schedule a final inspection with the Division. If the requirements of this Part have been met upon completion of construction and final inspection, the Division will issue a Certificate of Approval for the operation of the airport or RLA to the applicant.
- j) If the applicant is unable to complete construction of the airport or RLA, or, if the requirements of this Part have not been met within 18 months of the effective date of the Order, the applicant may request in writing, at the address noted in Section 14.100(d), an extension of time of the expiration date noted in the Order. The applicant must state the reasons for requesting the extension of time (e.g., weather delays, financial reasons) in the written request. The Division may grant or deny an extension of time based on whether the applicant has shown good cause to justify the request. If an extension of time is granted, the additional period of time allowed will be at the Division's discretion. If a request for an extension of time is denied, or if the minimum standards of this Part cannot be met, the application for a Certificate of Approval becomes null and void on the date the Order expires.

Section 14.120 Transfer/Modification/Rescission of Certificate of Approval

All forms referenced in this Section may be obtained from the Division as noted in Section 14.100(d).

- a) Transfer of Certificate of Approval. Any applicant desiring to have an airport or RLA Certificate of Approval transferred to his name must complete the following process.
 - 1) Complete and sign an Application to Transfer Certificate of Approval form (Form AER 2058). This application must also be signed by the present Certificate Holder (if available) and notarized. An original application must be mailed or delivered to the Division at the address noted in Section 14.100(d).
 - 2) Include proof that the applicant has the authority to operate the requested airport or RLA on the subject property as evidenced by:
 - A) the written approval of the prior Certificate Holder or, if deceased, executor or administrator of the estate, or
 - B) a copy of the deed or long-term lease.
 - 3) Division personnel will visit the airport or RLA, as early as Division priorities will allow, to determine whether it meets the minimum standards found in this Part, or, whether it meets the minimum standards in effect at the time of certification for the operation of an airport or RLA, before a transfer will be approved.
 - A) If the Division finds that the minimum standards have been met, the Division will issue an Order approving the transfer of the Certificate of Approval that will become effective immediately, with a copy simultaneously mailed to the applicant along with a new Certificate of Approval. No Notice is required for this action and the Order is not required to be published in the newspaper.
 - B) If the minimum standards of this Part have not been met, or, if the airport or RLA is not in compliance with the minimum standards in effect at the time of certification, the Division will advise the applicant as to what corrective measures need to be taken to achieve compliance (e.g., cut trees, clear brush). Once the Division has determined that standards have been met, the Division will issue an Order approving the transfer of the

Certificate of Approval that will become effective immediately, with a copy simultaneously mailed to the applicant along with a new Certificate of Approval.

- b) Modification of Certificate of Approval. No person shall make an extension or alteration to an existing airport or RLA that will require a modification of the Certificate of Approval without first having secured an Order from the Division approving the extension or alteration. Extensions or alterations will be considered in accordance with the applicable standards provided in either Section 14.510(a), 610(a), 710(a) or 810(a).
- 1) The Certificate Holder shall complete an Application for Approval of Extension or Alteration to an Airport or RLA form (Form AER 2057) and shall state the nature of the proposed extension or alteration to the airport or RLA in the application. An extension or alteration requiring a modification to the Certificate of Approval includes, but is not limited to the following:
- A) Construction, realignment, alteration or activation of any runway or other aircraft landing or takeoff area on an airport or RLA, or a taxiway associated with a landing or takeoff area on an airport or RLA, that causes any material change in the length, width or direction of any runway, other aircraft landing or takeoff area, or taxiway on an airport or RLA.
 - B) Change of any traffic pattern or traffic pattern altitude or direction.
 - C) Construction or installation of any building or other structure on the airport or RLA property that would extend above an approach slope, transition slope or turning zone.
 - D) Planting or permitting to grow any vegetation or placement of any other obstacle on the airport or RLA property that would extend above an approach slope, transition slope or turning zone.
 - E) Discontinuance of any runway or other aircraft landing or takeoff area of an airport or RLA, as such, or any taxiway associated with a landing or takeoff area of an airport or RLA, for a period of one year or more.
 - F) Change in status of an airport or RLA from private-use to public-use, or change in status of any airport from public-use to private-use or RLA.

- 2) If the extension or alteration is such that a FAA Form 7480-1 must be submitted to the FAA for airspace approval (the requirements are listed on the instruction sheet for the Form 7480-1), the Division will submit the form on behalf of the applicant.
- 3) Once the Division has received a favorable airspace determination from the FAA (in approximately 30-60 days), if required, the applicant will be notified in writing and the Division will proceed in processing Form AER 2057. If the FAA issues a non-favorable airspace determination, the applicant will be notified in writing as to what criteria needs to be met to receive a favorable determination (e.g., obstruction removed).
- 4) The Division will publish a Notice in the local newspaper, within the county where the airport or RLA is located, indicating that the Division intends to publish an Order granting or denying the modification to the Certificate of Approval, with a copy of the Notice simultaneously mailed to the applicant. All interested persons may, prior to the publication of the Order in the newspaper, file objections to or comments on the proposed Order by writing to the Division, at the address noted in Section 14.100(d), within 15 days after the date of publication of the Notice in the newspaper. The Division will consider any comments or opposition received within the 15-day period prior to making a decision to grant or deny a modification of the Certificate of Approval and prior to publishing the Order. (See Section 60 of the Act.)
- 5) If no comments or opposition to the proposed extension or alteration of the airport or RLA are received by the Division within the 15-day period, the Division will publish an Order in the local newspaper, within the county where the airport or RLA is located, approving the proposed extension or alteration of the airport or RLA and the modification of the Certificate of Approval, with a copy simultaneously mailed to the applicant. The Order will include a description of the proposed extension or alteration, any terms and restrictions (e.g., runway orientation, length) associated with the issuance of a modified Certificate of Approval, a completion date for the extension or alteration, and a provision that a final inspection of the airport or RLA is to be conducted prior to the issuance of the modified Certificate of Approval.
- 6) After the Order is published, interested persons may write or e-mail comments to the Division, or request a hearing in writing (see Subpart K), at the address noted in Section 14.100(d), as to the validity or reasonableness of the Order. Comments will be accepted for a 15-day

period after publication of the Order in the local newspaper. Unless the Division finds that a hearing is necessary or that a longer period of time is appropriate, the Order will be effective 20 days after publication in the local newspaper. A modified Certificate of Approval may be issued to the Certificate Holder anytime after the effective date of the Order. The Division will consider any comments received within the 15-day period prior to making a decision to grant or deny a modified Certificate of Approval. (See Section 60 of the Act.)

- 7) If a hearing is requested, the Division will schedule it at the earliest date possible in the county seat of the county where the airport or RLA is located. All interested persons will be notified in writing at least 10 days prior to the scheduled date of the hearing. After the hearing has been held, the Division will issue a Supplemental Order indicating the findings and conclusions of the hearing and whether the original Order will stand or whether it will be modified. A copy of the Supplemental Order will be mailed to the Certificate Holder as well as to the person or persons requesting the hearing.
- 8) The Certificate Holder will have 18 months from the effective date of the Order to complete the extension or alteration of the airport or RLA. The Certificate Holder shall contact the Division in writing or by phone, as noted in Section 14.100(d), within 30 days after the completion of the extension or alteration of the airport or RLA to schedule a final inspection with the Division. If the minimum standards of this Part have been met upon completion of the extension or alteration and final inspection, the Division will issue a modified Certificate of Approval to the Certificate Holder for the operation of the airport or RLA that includes any extension or alteration made to the airport or RLA.
- 9) If the Certificate Holder is unable to complete the extension or alteration of the airport or RLA within 18 months of the effective date of the Order, the Certificate Holder may request in writing, at the address noted in Section 14.100(d), an extension of time of the expiration date in the Order. The Certificate Holder must state the reasons for requesting the extension of time (e.g., delay in starting the project, weather delays) in the written request. The Division may grant or deny an extension of time based on whether the Certificate Holder has shown good cause to justify the request. If an extension of time is granted, the additional period of time allowed will be at the Division's discretion. If the request for an extension of time is denied, the application for the extension or alteration to the airport or RLA becomes null and void on the date the Order expires.

-
- 10) The Division may initiate the modification of a Certificate of Approval if it finds, upon inspection, that the airport or RLA is not being operated in accordance with this Part or with the standards in effect at the time the original Certificate of Approval was issued for the airport or RLA. Modifications will be made after the issuance of a Notice, Order and opportunity to be heard as outlined in subsections (b)(4), (5), (6) and (7) of this Section.
- c) Rescission of Certificate of Approval. The Certificate Holder, the property owner, and the Division each have the authority to request that a Certificate of Approval to operate an airport or RLA in Illinois be rescinded. Additionally, rescission may be accomplished by Operation of Law as provided in subsection (c)(4) of this Section.
- 1) Rescission by Certificate Holder. The Certificate Holder shall submit a completed Rescission of Certificate of Approval form (Form AER 2548) authorizing the closing of an airport or RLA and requesting that the Division rescind the Certificate of Approval. The form shall include the reasons for the rescission. A voluntary rescission by the Certificate Holder requires that the Division issue an Order of Rescission and mail a copy to the Certificate Holder. No Notice is required. The Order is not required to be published in the local newspaper but will be entered into the Division's records.
 - 2) Rescission by Property Owner. The owner of the property that an airport or RLA is located upon shall submit a completed Rescission of Certificate of Approval form authorizing the closing of an airport or RLA and requesting that the Division rescind the Certificate of Approval. The form shall include the reason(s) for the rescission, as well as a notarized statement indicating that the Certificate Holder no longer has the authority to operate the airport or RLA on the subject property. A voluntary rescission by the property owner requires the Division to issue an Order of Rescission and mail copies to the property owner and the Certificate Holder. No Notice is required. The Order is not required to be published in the local newspaper but will be entered into the Division's record.
 - 3) Rescission by the Division. The Division will rescind a Certificate of Approval if it finds that an airport or RLA is not being operated in accordance with this Part, or is not safe or is not being maintained or operated safely. The abandonment of an airport or RLA for a period of two consecutive years shall be just cause for the Division to rescind a Certificate of Approval. Any rescission by the Division will be after the issuance of a Notice, Order and an opportunity to be heard as outlined in

subsections (b)(4), (5), (6) and (7) of this Section. (See Section 49 of the Act.)

- 4) Rescission by Operation of Law. Each Certificate of Approval will automatically expire, with no further action required, upon the death of the Certificate Holder or dissolution of the corporation, Limited Liability Company (LLC), Limited Liability Partnership (LLP), Association, etc. holding the Certificate of Approval, unless the Division receives an Application to Transfer Certificate of Approval form (Form AER 2058) and the airport or RLA is in compliance with the minimum standards of this Part.

Section 14.130 Waivers

- a) The Division may waive strict compliance with any portion of this Part in connection with any particular application or request for a waiver, if the applicant demonstrates that the waiver:
 - 1) is necessary;
 - 2) will not adversely affect air traffic;
 - 3) will not interfere with future development of the airport or RLA;
 - 4) will not substantially impair the safety of the public's use of the airport; and
 - 5) will not diminish the safety of those using or living near the airport or RLA (i.e., the applicant must produce documentation indicating that the aircraft he proposes to utilize at the airport or RLA only requires a short strip for takeoff and landing, thereby allowing a waiver of the minimum length requirements).

- b) In evaluating a request for a waiver, the Division will consider, but is not limited to considering:
 - 1) the volume and type of aircraft using the airport or RLA;
 - 2) the navigational aids;
 - 3) the length and width of the landing strip;
 - 4) the instrument approaches;
 - 5) the function of the airport or RLA in the current national and State airport and airway plan;
 - 6) the nature of the terrain;
 - 7) the possibilities for future development;
 - 8) the proximity to neighbors;
 - 9) the population density; and

-
- 10) the pattern agreements.
- c) The applicant must complete and sign an Application for Waiver form (Form AER 2056) that shall be submitted with the application for Certificate of Approval for an airport or RLA, or for an extension or alteration of an existing airport or RLA, in accordance with Section 14.115 and Section 14.120. The Application for Waiver must contain clear and concise statements of the facts together with a request that a certain regulation be waived.
- d) An Application for Waiver will be checked for accuracy by Division personnel and must be approved by the Bureau Chief of Aviation Safety and the Director of the Division. The applicant will be notified by the Division either in writing or by telephone, as soon as Division priorities will allow, as to whether the Application for Waiver has been approved.
- e) All decisions either approving or disapproving requests for waivers are final and are reviewable pursuant to Section 14.1196, Administrative Review.

SUBPART B: AIRCRAFT REGISTRATION

Section 14.200 Registration of Aircraft

Except as provided in Section 14.230, no person shall operate, or authorize to be operated, any civil aircraft in Illinois unless that aircraft has an appropriate effective license, airworthiness certificate or permit issued by the FAA for which a certificate of registration has been issued by the Division that is in full force and effect. (See Section 43 of the Act.)

Section 14.210 Time and Manner of Registration

All forms referenced in this Section may be obtained from the Division at the address noted in Section 14.100(d).

- a) Except as provided in Section 14.230, all holders of Federal Aircraft Certificates for aircraft engaged in air navigation in Illinois shall complete an Application for Registration of Federal Aircraft Certificate form (Form AER 2048) within 30 days after establishing residency in Illinois or within 30 days after purchasing an aircraft. Each completed application shall contain at least the same information that is shown on the Federal Aircraft Certificate.
- b) The fee for the registration or transfer of registration of each Federal Aircraft Certificate is \$20.00 when paid within the first year of the current biennial registration cycle. Persons who register within the second year of the current biennial cycle must pay \$10.00. Remittance shall be payable to the State Treasurer of Illinois and shall be included at the time the application for registration is submitted to the Division. (See Section 42 of the Act.)
- c) The Division will then issue a biennial Certificate of Registration and a Decal that are required to be carried at all times in or on an aircraft engaged in air navigation in Illinois (see Section 14.220) and that will automatically expire upon transfer of ownership of the aircraft or on the date indicated on the Certificate of Registration. The Certificate of Registration and Decal will be mailed to the registrant as early as Division priorities allow. Each biennial registration cycle begins January 1 of all even years and expires December 31 of the following odd year. Renewal notices are mailed at the beginning of each cycle.
- d) No formal hearing will be held concerning an application for a Certificate of Registration. If additional information is needed, the Division may inquire about or investigate an application.

Section 14.220 Exhibition of Certificates and Decal

- a) Each Federal Aircraft Certificate and the Certificate of Registration and Decal issued by the Division shall be carried at all times in or on the aircraft engaged in air navigation in Illinois. Each certificate must be posted where it may be readily seen by passengers or inspectors (i.e., on the pocket of the kick panel) and must be presented for inspection upon demand by any passenger, any peace officer of this state, any officer or authorized employee or designee of the Division, or any official, manager or person in charge of any airport or RLA in Illinois upon which the aircraft lands. The Decal issued by the Division shall be affixed to the aircraft as prescribed in the instructions (above or near the "N" number on the right side of the aircraft) included with the Decal. (See Section 45 of the Act.)
- b) In the event of loss, mutilation, correction (i.e., name change) or destruction of a Certificate of Registration or Decal, the owner of a registered aircraft may obtain a duplicate from the Division upon notifying the Division in writing and submitting a payment of \$5.00 made payable to the State Treasurer of Illinois.

Section 14.230 Exceptions to Registration Requirements

Sections 14.200, 210 and 220 do not apply to subsections (a) - (f) of this Section provided the aircraft complies with all other applicable Sections of this Part.

- a) An aircraft licensed by a foreign country with which the United States has a reciprocal agreement covering the operations of the licensed aircraft.
- b) An aircraft owned by a non-resident person of the state of Illinois lawfully entitled to operate the aircraft in the state of his or its residence.
- c) An aircraft engaged principally in commercial flying constituting an act of interstate or foreign commerce.
- d) An aircraft while being transported in the possession of, or while being demonstrated to a potential buyer by a bonafide aircraft manufacturer, distributor or dealership.
- e) Ultralights and Ultralight Trainers (although the Division encourages registration).
- f) Publicly owned aircraft including military aircraft. (See Section 44 of the Act.)

SUBPART C: AIRMAN REGISTRATION

Section 14.300 Registration of Airman

Except as provided in Section 14.330, no person shall engage in the operation of an aircraft in Illinois unless he has obtained from the Division an effective registration of his current and appropriate airman certificate as issued by the FAA. No person shall engage in the operation of aircraft in Illinois unless current and qualified under 14 CFR 61, effective October 1, 2002. (See Section 43 of the Act.)

Section 14.310 Time and Manner of Registration

All forms referenced in this Section may be obtained from the Division at the address noted in Section 14.100(d).

- a) Except as provided in Section 14.330, all holders of Federal Airman Certificates engaged in the operation of aircraft in Illinois shall complete a Biennial Application for Registration of Federal Airman Certificate form (Form AER 1967) within 30 days after establishing residency in Illinois. Each completed application shall contain at least the same information that is shown on the Federal Airman Certificate, including all ratings attached to the certificate.
- b) The fee for the registration of each Federal Airman Certificate is \$10.00 when paid within the first year of the current biennial registration cycle. Persons who register within the second year of the current biennial cycle must pay \$5.00. Remittance shall be payable to the State Treasurer of Illinois and shall be included at the time the application for registration is submitted to the Division. (See Section 42 of the Act.)
- c) The Division will then issue a biennial Certificate of Registration that will automatically expire on the date indicated on the Certificate of Registration. The Certificate of Registration will be mailed to the registrant as early as Division priorities allow. Each biennial registration cycle begins January 1 of all even years and expires December 31 of the following odd year. Renewal notices are mailed at the beginning of each cycle.
- d) No formal hearing will be held concerning an application for a Certificate of Registration. If additional information is needed, the Division may inquire about or investigate an application.

Section 14.320 Exhibition of Certificates

- a) The Federal Airman Certificate and the Division's Certificate of Registration shall be kept in the personal possession of the pilot when he is operating an aircraft in Illinois. Both certificates must be presented for inspection upon demand by any passenger, any peace officer of this state, any officer or authorized employee or designee of the Division, or any official, manager or person in charge of any airport or RLA in Illinois upon which the airman lands. (See Section 45 of the Act.)
- b) In the event of loss, mutilation, correction (e.g., name change) or destruction of a Certificate of Registration, an airman may obtain a duplicate from the Division upon notifying the Division in writing and submitting a payment of \$3.00 made payable to the State Treasurer of Illinois.

Section 14.330 Exceptions to Registration Requirements

Sections 14.300, 310 and 320 do not apply to:

- a) A pilot operating military or public aircraft or any aircraft licensed by a foreign country with which the United States has a reciprocal agreement covering the operation of the licensed aircraft.
- b) Any person piloting an aircraft that is equipped with fully functioning dual controls, when a licensed instructor is in full charge of one set of controls and the flight is solely for instruction, or for the demonstration of the aircraft to a bonafide potential buyer.
- c) A non-resident, operating aircraft in Illinois lawfully entitled to operate aircraft in the state of his residence.
- d) Pilots and flight instructors solely engaged in the flight of Ultralights and Ultralight Trainers (although the Division encourages registration).
- e) A pilot operating or taking part in the operation of an aircraft engaged solely in commercial flying constituting an act of interstate or foreign commerce. (See Section 44 of the Act.)

SUBPART D: AIR SAFETY

Section 14.400 Applicability

This Subpart D applies to aircraft operated in the state of Illinois and the overlying airspace, except for aircraft engaged in special flight operations requiring deviation from this Subpart D that are conducted in accordance with the terms and conditions of a valid certificate of waiver issued by the FAA. For information on Special Purpose Aircraft and Ultralights, see Subparts I and J respectively. This Subpart D does not limit the authority of local officials to take appropriate action to stop, prevent or penalize individuals for or from creating a nuisance. Normal operations, however, do not constitute a nuisance.

Section 14.410 Responsibility and Authority of Pilot

The pilot-in-command of the aircraft shall be directly responsible for its operation and shall have final authority as to the operation of the aircraft. In emergency situations that require immediate decisions and actions (e.g., engine failure), the pilot-in-command may deviate from this Subpart D to the extent required for safety considerations. When emergency authority is exercised, the pilot-in-command, upon request of the Division, shall file a written report that, at a minimum, describes the circumstances of the emergency and how the pilot-in-command deviated from this Subpart D.

- a) Careless or Reckless Operation
 - 1) No pilot shall operate an aircraft in a careless or reckless manner so as to endanger the person or property of another.
 - 2) Examples of careless or reckless aircraft operation that may endanger the person or property of another are:
 - A) Buzzing, diving on, or flying in close proximity to livestock, homes, any structure, aircraft, vehicle, vessel, person or group of persons.
 - B) Operating the aircraft at an insufficient altitude so as to endanger a person or property on the surface or passengers within the aircraft.
 - C) Lacking vigilance by the pilot to observe and avoid other air traffic.
 - D) Knowingly and substantially violating airport traffic rules established by the FAA or the airport owner.
 - E) Operating an aircraft without meeting the FAA's minimum qualifications and currency requirements for pilots.
- b) Proximity of Aircraft. No pilot shall operate an aircraft in proximity to or on a course relative to other aircraft so as to create a collision hazard. No aircraft shall be operated in formation flight except by pre-arrangement between the pilot-in-command of each aircraft. No pilot shall operate an aircraft in formation flight when passengers are carried for hire.
- c) Aerobatic Flight

- 1) No pilot shall intentionally fly an aircraft in aerobatic flight unless each occupant is equipped with a FAA approved parachute. Aerobatic flight relating to this Part means:
 - A) A bank in excess of 60° relative to the horizon; or
 - B) A nose up or nose down attitude in excess of 30° relative to the horizon.
- 2) No pilot shall engage in aerobatic flight under the following conditions:
 - A) Over congested areas of cities, towns, settlements, or over an open-air assembly of persons.
 - B) Within any FAA designated airway or within the lateral boundaries of the surface areas of Class B, Class C, Class D or Class E airspace designated for an airport.
 - C) When the flight visibility is less than three statute miles.
 - D) Below an altitude of 1,500 feet above the surface.
- 3) Subsection (c)(1) of this Section does not apply to:
 - A) Flight tests for pilot certification or rating; or
 - B) Spins and other flight maneuvers required by FAA regulations for any certificate or rating when given by:
 - i) An authorized flight instructor; or
 - ii) An airline transport pilot instructing in accordance with 14 CFR 61, effective October 1, 2002.
- d) Minimum Safe Altitudes. Except when necessary for takeoff or landing, and except as permitted by a FAA low flying waiver, no pilot shall operate an aircraft below the following altitudes at the following locations:
 - 1) Anywhere. An altitude that will permit, in the event of the failure of a power unit, an emergency landing without hazard to a person or property on the surface.

- 2) Over a Congested Area. Over any congested area of a city, town or settlement, or over any open-air assembly of persons, an altitude of 1,000 feet above the highest obstacle within a horizontal radius of 2,000 feet of the aircraft. Helicopters and aircraft having similar flight characteristics may be flown at less than the minimum prescribed in this subsection (d)(2) if such operations are conducted without hazard to or disturbance of persons or property on the surface and in accordance with subsection (d) of this Section. However, the Division, in the interest of safety, may prescribe specific routes and altitudes for the operations, with which Special Purpose Aircraft shall conform.
 - 3) Over an Area Other Than Congested Area. At an altitude of 500 feet above the surface, except over open water or sparsely populated areas. In these cases, the aircraft shall not be operated closer than 500 feet to any person, vessel, vehicle or structure. Helicopters may be flown at less than the minimums prescribed in this subsection (d)(3) if the operations are conducted without hazard to a person or property on the surface, and in accordance with subsection (d) of this Section.
- e) Aircraft Lights
- 1) Between sunset and sunrise, all aircraft in flight or operated on the ground, or under way on the water, shall display position lights and approved aviation red or aviation white anti-collision lights if so equipped.
 - 2) Between sunrise and sunset, all aircraft in flight shall display approved aviation red or aviation white anti-collision lights. However, the anti-collision lights need not be lighted if the pilot-in-command determines, due to operating conditions and in the interest of safety, the lights need not be on.
- f) Visual Flight Rules (VFR) – Basic VFR Weather Minimums
- 1) Except as provided in 14 CFR 91.155(b) or 14 CFR 91.157, effective October 1, 2002, no pilot may operate an aircraft under VFR when the flight visibility is less, or at a distance from clouds that is less, than that prescribed in 14 CFR 91.155(a), effective October 1, 2002.
 - 2) When the visibility is less than one statute mile, a helicopter may be operated outside Class E airspace at 1,200 feet or less above the surface, if operated at a speed that allows the pilot adequate opportunity to see any air traffic or other obstruction in time to avoid a collision.

- 3) Except as provided in subsection (g) of this Section, no pilot may operate an aircraft beneath the ceiling within the lateral boundaries of Class E airspace designated to the surface for an airport, under VFR, when the ceiling is less than 1,000 feet.
 - 4) Except as provided in subsection (g) of this Section, no person may takeoff or land an aircraft, or enter the traffic pattern of an airport, under VFR, within the lateral boundaries of the surface areas of Class B, Class C, Class D or Class E airspace designated for an airport unless:
 - A) Ground visibility at that airport is at least three statute miles; or
 - B) If ground visibility is not reported at that airport, flight visibility during landing or takeoff, or while operating in the traffic pattern, is at least three statute miles.
 - 5) For the purposes of subsection (f) of this Section, an aircraft operating at the base altitude of Class E airspace is considered to be within the airspace directly below that area.
- g) Visual Flight Rules – Special VFR Weather Minimums.
- 1) When a pilot has received an appropriate Air Traffic Control (ATC) clearance, the special weather minimums of this subsection (g)(1), instead of those contained in subsection (f) of this Section, apply to the operation of an aircraft under VFR by that pilot in a Class B, Class C, Class D or Class E airspace designated for an airport.
 - 2) No pilot may operate an aircraft, other than a helicopter, under special VFR clearance, unless one statute mile of flight visibility and clear of clouds is maintained.
 - 3) Except for helicopters, no pilot may operate an aircraft under special VFR clearance between sunset and sunrise, unless that person meets the requirements for instrument flight under 14 CFR 61, effective October 1, 2002, and the aircraft is equipped as required in 14 CFR 91.205(d), effective October 1, 2002.
- h) VFR Cruising Altitude or Flight Level. Except while holding in a holding pattern of two minutes or less, or while turning, each pilot operating an aircraft under VFR in level cruising flight, more than 3,000 feet above the surface, shall maintain the appropriate altitude prescribed below.

-
- 1) When operating below 18,000 feet mean sea level (MSL) and:
 - A) On a magnetic course of zero degrees through 179 degrees, any odd thousand foot MSL altitude + 500 feet (such as 3,500, 5,500 or 7,500); or
 - B) On a magnetic course of 180 degrees through 359 degrees, any even thousand foot MSL altitude + 500 feet (such as 4,500, 6,500 or 8,500).
 - 2) VFR Flight above 18,000 feet MSL is prohibited throughout the conterminous United States.

Section 14.420 Use of Liquor, Narcotics and Drugs

- a) No person may act as a pilot or required crewmember of a civil aircraft:
 - 1) within eight hours after the consumption of any alcoholic beverage;
 - 2) while under the influence of alcohol;
 - 3) while using any drug that affects his faculties in any way contrary to safety; or
 - 4) while having .04 percent by weight or more alcohol in the blood. (See Section 43(d) of the Act.)

- b) Except in an emergency, no pilot of a civil aircraft may allow a person who appears to be under the influence of intoxicating liquors or drugs (except a medical patient under proper care) to be carried as a passenger in that aircraft.

Section 14.430 Transportation of Explosives, Dangerous Articles or Illegal Substances

- a) No person piloting an aircraft shall permit explosives or other dangerous articles or material such as flammable liquids or solids, oxidizing materials, corrosive liquids or solids, or tear gas to be carried in aircraft, unless carried, contained and transported in a safe (by federal standards) manner. Small arms and ammunition for personal use consistent with applicable federal and State laws, necessary aircraft signaling devices and equipment necessary for the safe operation of the aircraft are permitted.
- b) The transportation of illegal substances is prohibited.

Section 14.440 Dropping Objects from Aircraft

- a) No person, while operating or riding in any type of aircraft, shall cause to be dropped any object used to publicize or advertise any product, service, activity or event; including circulars, posters, handbills or other advertising matter.
- b) No person, owner or lessee, while operating or riding in any type of aircraft, may cause to be dropped any other object, unless he applies for and receives a dropping permit from the Division. Permit forms can be obtained by contacting the Division at the address noted in Section 14.100(d).
 - 1) The completed permit form must be received at least 14 days prior to the date of the scheduled drop.
 - 2) The permit form must specify the name and address of the person who will be authorized to make the drop, as well as the date, time and place for the drop and the object to be dropped.
 - 3) Approval is contingent upon whether the drop will constitute a safety hazard. If approved, the permit will be mailed to the person making the request before the day of the scheduled drop. (See Section 43(b) of the Act.)
- c) This Section does not prohibit the otherwise lawful use of aircraft for agricultural applications, fire suppression or pest control. The operator of an aircraft engaging in aerial applications shall carry on his person a permit issued by the State of Illinois, Department of Agriculture. (See Section 43(b) of the Act.)

Section 14.450 Fuel Requirements for Flight in VFR Conditions

- a) No pilot shall begin a flight in an airplane under VFR conditions unless, considering wind and forecast weather conditions, there is enough fuel to fly to the first point of intended landing and, assuming normal cruising speed:
 - 1) during the day, to fly after that for at least 30 minutes; or
 - 2) at night, to fly after that for at least 45 minutes.

- b) No pilot shall begin a flight in a rotorcraft under VFR conditions unless, considering wind and forecast weather conditions, there is enough fuel to fly to the first point of intended landing and, assuming normal cruising speed, to fly after that for at least 20 minutes.

Section 14.460 Fuel Requirements for Flight in IFR Conditions

- a) Except as provided in subsection (b) of this Section, no pilot shall operate a civil aircraft in Instrument Flight Rule (IFR) conditions unless it carries enough fuel, considering weather reports and forecasts, and weather conditions, to:
 - 1) complete the flight to the first airport of intended landing; and
 - 2) fly from that airport to the alternate airport; and
 - 3) fly after that for 45 minutes at normal cruising speed or, for rotorcraft, fly after that for 30 minutes at normal cruising speed.
- b) Subsection (a)(2) of this Section does not apply if:
 - 1) 14 CFR 97, effective October 1, 2002, prescribes a standard instrument approach procedure for the first airport of intended landing; and
 - 2) for at least one hour before and one hour after the estimated time of arrival at the airport, the weather reports or forecasts, or any combination of them indicate:
 - A) the ceiling will be at least 2,000 feet above the airport elevation; and
 - B) visibility will be at least three statute miles.

SUBPART E: AIRPORTS

Section 14.500 Airport Classification

Airports and Ultralight/Short Takeoff and Landing (STOL) Airports shall be classified as public-use or private-use. For purposes of this Subpart E, the word "airport" includes Ultralight/STOL airports. The minimum standards for the establishment, management or operation of airports shall be in accordance with this Subpart E, including the minimum dimensional standards for airports as shown in Section 14.Appendix A, Illustrations A, B, C and D.

Section 14.510 Application for Certificate of Approval

- a) New Airports. The Division will issue a Certificate of Approval for an airport in accordance with Section 14.115, taking into consideration:
 - 1) the airport's proposed location;
 - 2) the airport's size and layout;
 - 3) the relationship of the proposed airport to the then current State and Federal Airport and Airways System;
 - 4) whether there are safe areas available for expansion purposes;
 - 5) whether the adjoining areas are free from obstructions based on a proper glide ratio;
 - 6) the nature of the terrain;
 - 7) the nature of the uses to which the proposed airport will be put;
 - 8) the possibilities for future development; and
 - 9) the minimum standards contained in this Subpart E, including Section 14.Appendix A, Illustrations A, B, C and D. (See Section 48 of the Act.)
- b) Transfer of Certificate of Approval. The Division will issue a new Certificate of Approval for the transfer of an airport in accordance with Section 14.120(a).
- c) Modification of Certificate of Approval. The Division will issue a new Certificate of Approval after completion of an airport extension or alteration that requires a modification of the Certificate of Approval in accordance with Section 14.120(b).

Section 14.520 Design and Layout Requirements

The minimum airport design and layout requirements shall be in accordance with subsections (a) and (b) of this Section, and with the standards and limitations shown in Section 14.Appendix A, Illustrations A, B, C and D.

- a) **Multiple Runway Airport.** Relative to the minimum standards for an airport, the Division will not recognize any additional landing area as a runway or landing strip, unless the proposed second or additional landing area has a runway length of at least 80% of the effective length of the primary runway, or unless it is a designated STOL runway. To be a designated STOL runway, it must meet the criteria as prescribed in Section 14.Appendix A, Illustrations C and D.
- b) **Line of Sight (LOS).** Runway grades, terrain, structures, and permanent objects must be such that there will be an unobstructed LOS from any point five feet above one runway centerline to a point five feet above an intersecting runway centerline, both points being within the area of the runway's visibility zone. The runway's visibility zone is an area formed by connecting points located 50% of the distance between runway ends and the runway intersection. Additionally, LOS between same runway ends from a point five feet above the ends must be maintained. (See Section 14.Appendix A, Illustration E.)

Section 14.530 Obstructions

In order to be eligible for a Certificate of Approval under this Part, an airport must initially and continually be free of obstructions (e.g., buildings, trees, power poles, etc.) on all runway or landing approach/departure surfaces. Glide ratios and height limitations are shown in Section 14.Appendix A, Illustrations A and C.

Section 14.540 Airport Marking

- a) Every airport shall be marked so that the usable landing area is clearly defined as observed from an altitude of 1500' above ground level (AGL) in accordance with Section 14.Appendix A, Illustrations F and G.
- b) Airports that have a non-standard traffic pattern are required to have a segmented circle with traffic arms. Section 14.Appendix A, Illustration H depicts the dimensional standards for a segmented circle.
- c) Displaced thresholds (based on a 20:1 approach over all obstructions) shall be clearly marked in accordance with Section 14.Appendix A, Illustration I.
- d) All obstructions, such as pole lines that extend above a 20:1 approach slope measured from the physical end of the runway, that are difficult for pilots to observe readily from the air shall be clearly marked.
- e) All obstructions or field conditions that constitute a hazard to aircraft on the ground, shall be clearly marked and visible from the air (e.g., yellow tape, orange cones).

Section 14.550 Facilities

Every airport shall provide at least the minimum facilities as prescribed in Section 14.Appendix B, Table A.

Section 14.560 Responsibility of a Public-Use Airport Certificate Holder

The holder of a Certificate of Approval for a public-use airport, or his authorized agent, has the responsibility to enforce applicable federal, State and local aeronautical laws, and regulations of this Part. In addition to maintaining the terms and conditions outlined in the Certificate of Approval and its supporting Order, the Certificate Holder or his agent must:

- a) Immediately designate any condition that may render an aircraft landing or takeoff hazardous (e.g., rough terrain, soft ground) by prominently displaying an "X" as set forth in Section 14.Appendix A, Illustration J; and, also, by notifying the appropriate Federal Aviation Administration Flight Service Station (FAA-FSS) of those conditions. All other hazardous conditions (e.g., snow or ice on runway) should be reported immediately or NOTAMED (Notice to Airmen) to the FAA-FSS.
- b) Supervise or cause the supervision of all aeronautical activity in connection with the airport in the interest of public safety, except activity that may be controlled by an authorized air traffic control facility.
- c) Have authorized personnel in attendance at the airport at all times during normal business hours (i.e., 8:00 AM to 5:00 PM). In the event that it is impractical to comply with the foregoing, the Certificate Holder or his agent shall post a prominent notice of the existing situation and provide a telephone number for assistance.
- d) Ensure that the airport has a phone number by which Division personnel can reach the Certificate Holder or his designee. In the event that the Certificate Holder or his designee is not available at the airport number, an answering device at the airport number shall provide a message identifying a reliable secondary number where the Certificate Holder or his designee can be reached. It is mandatory that any change in Certificate Holder/designee address or phone number be reported to the Division in writing, by phone or e-mail at the address provided in Section 14.115(a), within 10 days after the change.
- e) Prescribe local airport rules that will be reviewed and approved, prior to their adoption, by the Division.
- f) Develop and follow, on the property subject to his control, operational maintenance and repair practices that will ensure that the landing area and approaches are free from hazards to the operation of aircraft.

-
- g) Furnish the Division, upon request, with information concerning aircraft using the airport as an operating base, persons exercising managerial or supervisory functions at the airport, accidents, and the nature and extent of aeronautical activity occurring at the airport.

 - h) Obliterate all signs and markings that might indicate that the airport is still operating, prior to the Division issuing an Order closing the airport, in accordance with Section 14.120(c). Place an "X" on the field, as set forth in Section 14.Appendix A, Illustration J, unless the airport is, or is proposed to be, operated as an RLA.

Section 14.570 Responsibility of a Private-Use Airport Certificate Holder

The holder of a Certificate of Approval for a private-use airport, or his authorized agent, has the responsibility to enforce applicable federal, State and local aeronautical laws, and regulations of this Part. In addition to maintaining the terms and conditions outlined in the Certificate of Approval and its supporting Order, the Certificate Holder or his agent must:

- a) Immediately designate any condition that may render an aircraft landing or takeoff hazardous by prominently displaying an "X" as set forth in Section 14.Appendix A, Illustration J.
- b) Supervise or cause the supervision of all aeronautical activity in connection with the airport in the interest of safety.
- c) Ensure that the airport has a phone number by which Division personnel can reach the Certificate Holder or his designee. In the event that the Certificate Holder or his designee is not available at the airport number, an answering device at the airport number shall provide a message identifying a reliable secondary number where the Certificate Holder or his designee can be reached. It is mandatory that any change in Certificate Holder/designee address or phone number be reported to the Division in writing, by phone or e-mail at the address provided in Section 14.115(a), within 10 days after the change.
- d) Prescribe local airport rules that will be reviewed and approved, prior to their adoption, by the Division.
- e) Develop and follow, on the property subject to his control, operational maintenance and repair practices that will ensure that the landing area and approaches are free from hazards to the operation of aircraft.
- f) Furnish the Division, upon request, with information concerning aircraft using the airport as an operating base, persons exercising managerial or supervisory functions at the airport, accidents, and the nature and extent of aeronautical activity occurring at the airport.
- g) Obliterate all signs and markings that might indicate that the airport is still operating, prior to the Division issuing an Order closing the airport, in accordance with Section 14.120(c). Place an "X" on the field, as set forth in Section 14.Appendix A, Illustration J, unless the airport is, or is proposed to be, operated as an RLA.

Section14.580 Restrictions on Use

For restrictions on use see Section 14.Appendix B, Table B.

SUBPART F: AIRPORTS FOR NON-CONVENTIONAL AIRCRAFT

Section 14.600 Airport Classification

Airports designated as seaplane bases or landing areas for seaplanes, or for non-conventional types of aircraft such as lighter-than-air aircraft or balloons shall be classified as public-use or private-use. The minimum standards for the establishment, management or operation of airports for non-conventional aircraft shall be in accordance with this Subpart F, including the minimum dimensional standards as shown in Section 14.Appendix C, Illustration A.

Section 14.610 Application for Certificate of Approval

Issuance of a Certificate of Approval to an operator of an airport for non-conventional aircraft does not exempt the operator from compliance with all applicable federal, State and local regulations.

- a) New Airports. The Division will issue a Certificate of Approval for an airport for non-conventional aircraft in accordance with Section 14.115, taking into consideration:
 - 1) the airport's proposed location;
 - 2) the airport's size and layout;
 - 3) the relationship of the proposed airport to the then current State and Federal Airport and Airways System;
 - 4) whether there are safe areas available for expansion purposes;
 - 5) whether the adjoining areas are free from obstructions based on a proper glide ratio;
 - 6) the nature of the terrain;
 - 7) the nature of the uses to which the proposed airport will be put;
 - 8) the possibilities for future development; and
 - 9) the minimum standards contained in this Subpart F, including Section 14.Appendix C, Illustration A. (See Section 48 of the Act.)
- b) Transfer of Certificate of Approval. The Division will issue a new Certificate of Approval for the transfer of an airport in accordance with Section 14.120(a).
- c) Modification of Certificate of Approval. The Division will issue a new Certificate of Approval after completion of an airport extension or alteration that requires a modification to the Certificate of Approval in accordance with Section 14.120(b).

Section 14.620 Public-Use of Airports for Non-Conventional Aircraft

- a) Balloon Port.
 - 1) Physical Standards. The diameter of the launch circle shall be a minimum of 300 feet, as shown in Section 14.Appendix C, Illustration A.
 - 2) Minimum Departure Slope. A balloon port must provide a 1:1 departure slope as measured from the nearest edge of the circle throughout its entire 360° circumference. All public utility lines, towers of all types, and inhabited buildings or dwellings must be cleared by at least 5:1 as measured from the nearest edge of the circle.
 - 3) Facilities. Every balloon port shall provide:
 - A) Wind direction/velocity indicator (must be lighted for night use).
 - B) Adequate fire protection equipment.
 - C) Accessible telephone.
 - D) Potable water during business hours.
 - E) Sanitary restroom facilities.
 - F) First-aid kit.
 - 4) Responsibility of a Public-Use Balloon Port Certificate Holder.
 - A) Supervise or cause the supervision of all aeronautical activity in connection with the balloon port in the interest of public safety, except activity that may be controlled by an authorized air traffic control facility.
 - B) Have authorized personnel in attendance at the balloon port at all times during normal business hours (i.e., 8:00 AM to 5:00 PM). In the event that it is impractical to comply with the foregoing, the Certificate Holder or his agent shall post a prominent notice of the existing situation and provide a telephone number for assistance.
 - C) Ensure that the balloon port has a phone number by which Division personnel can reach the Certificate Holder or his

designee. In the event that the Certificate Holder or his designee is not available at this number, an answering device at the balloon port number shall provide a message identifying a reliable secondary number where the Certificate Holder or his designee can be reached. It is mandatory that any change in Certificate Holder/designee address or phone number be reported to the Division in writing, by phone or e-mail at the address provided for in Section 14.115(a), within 10 days of the change.

- D) Prescribe local balloon port rules that will be reviewed and approved, prior to their adoption, by the Division.
 - E) Develop and follow, on the property subject to his control, operational maintenance and repair practices, that will ensure that the landing area and approaches are free from hazards to the operation of aircraft.
 - F) Furnish the Division, upon request, with information concerning aircraft using the balloon port as an operating base, persons exercising managerial or supervisory functions at the balloon port, accidents, and the nature and extent of aeronautical activity occurring at the balloon port.
- b) Seaplane Base.
- 1) Physical Standards for Water Lane. Water landing and departure surfaces must be a minimum of 400 feet in width, as shown in Section 14.Appendix C, Illustration A.
 - 2) Water Lane Length and Minimum Clearances. The water lane length for all approaches to and takeoff from the water shall be sufficient to allow for a 100' clearance over all structures on land and water.
 - 3) Facilities. Every seaplane base shall provide:
 - A) Wind direction/velocity indicator (must be lighted for night use).
 - B) One 20# fire extinguisher (two with sale of fuel).
 - C) Accessible telephone.
 - D) Docking or beaching facility.

-
- E) Accessible emergency personal flotation device (life ring or preserver).
 - F) Potable water.
 - G) Sanitary restrooms.
 - H) First-aid kit.
 - I) Segmented circle with arms where a non-standard traffic pattern is used.
 - J) Fuel.
- 4) Responsibility of a Public-Use Seaplane Base Certificate Holder.
- A) Notify the appropriate FAA-FSS of hazardous conditions.
 - B) Supervise or cause the supervision of all aeronautical activity in connection with the seaplane base in the interest of public safety, except activity that may be controlled by an authorized air traffic control facility.
 - C) Have authorized personnel in attendance at the seaplane base at all times during normal business hours (i.e., 8:00 AM to 5:00 PM). In the event that it is impractical to comply with the foregoing, the Certificate Holder or his agent shall post a prominent notice of the existing situation and provide a telephone number for assistance.
 - D) Ensure that the seaplane base has a phone number by which Division personnel can reach the Certificate Holder or his designee. In the event that the Certificate Holder or his designee is not available at this number, an answering device at the seaplane base number shall provide a message identifying a reliable secondary number where the Certificate Holder or his designee can be reached. It is mandatory that any change in Certificate Holder/designee address or phone number be reported to the Division in writing, by phone or e-mail at the address provided for in Section 14.115(a), within 10 days after the change.
 - E) Prescribe local seaplane base rules that will be reviewed and approved, prior to their adoption, by the Division.

-
- F) Develop and follow, on the property subject to his control, operational maintenance and repair practices, that will ensure that the landing area and approaches are free from hazards to the operation of aircraft.

 - G) Furnish the Division, upon request, with information concerning aircraft using the seaplane base as an operating base, persons exercising managerial or supervisory functions at the seaplane base, accidents, and the nature and extent of aeronautical activity occurring at the seaplane base.

Section 14.630 Private-Use of Airports for Non-Conventional Aircraft

- a) Balloon Port.
 - 1) Physical Standards. The diameter of the launch circle shall be a minimum of 300 feet, as shown in Section 14.Appendix C, Illustration A.
 - 2) Minimum Departure Slope. A balloon port must provide a 1:1 departure slope as measured from the nearest edge of the circle throughout its entire 360° circumference. All public utility lines, towers of all types, and inhabited buildings or dwellings must be cleared by at least 5:1 as measured from the nearest edge of the circle.
 - 3) Facilities. Every balloon port shall provide a wind direction/velocity indicator (must be lighted for night use).
 - 4) Responsibility of a Private-Use Balloon Port Certificate Holder.
 - A) Supervise or cause the supervision of all aeronautical activity in connection with the balloon port in the interest of safety.
 - B) Ensure that the balloon port has a phone number by which Division personnel can reach the Certificate Holder or his designee. In the event that the Certificate Holder or his designee is not available at this number, an answering device at the balloon port number shall provide a message identifying a reliable secondary number where the Certificate Holder or his designee can be reached. It is mandatory that any change in Certificate Holder/designee address or phone number be reported to the Division in writing, by phone or e-mail at the address provided in Section 14.115(a), within 10 days after the change.
 - C) Prescribe local balloon port rules that will be reviewed and approved, prior to their adoption, by the Division.
 - D) Develop and follow, on the property subject to his control, operational maintenance and repair practices, that will ensure that the landing area and approaches are free from hazards to the operation of aircraft.
 - E) Furnish the Division, upon request, with information concerning aircraft using the balloon port as an operating base, persons

exercising managerial or supervisory functions at the balloon port, accidents, and the nature and extent of aeronautical activity occurring at the balloon port.

- b) Seaplane Base.
- 1) Physical Standards. Water landing and departure surfaces must be a minimum of 400 feet in width, as shown in Section 14.Appendix C, Illustration A.
 - 2) Minimum Clearances. All approaches to and departures from the water area shall be sufficient to clear all structures on the land or in the water by at least 100 feet.
 - 3) Facilities. Every seaplane base shall provide a wind direction/velocity indicator (must be lighted for night use).
 - 4) Responsibility of a Private-Use Seaplane Base Certificate Holder:
 - A) Supervise or cause the supervision of all aeronautical activity in connection with the seaplane base in the interest of safety.
 - B) Ensure that the seaplane base has a phone number by which Division personnel can reach the Certificate Holder or his designee. In the event that the Certificate Holder or his designee is not available at this number, an answering device at the seaplane base number shall provide a message identifying a reliable secondary number where the Certificate Holder or his designee can be reached. It is mandatory that any change in Certificate Holder/designee address or phone number be reported to the Division in writing, by phone or e-mail at the address provided in Section 14.115(a), within 10 days after the change.
 - C) Prescribe local seaplane base rules that will be reviewed and approved, prior to their adoption, by the Division.
 - D) Develop and follow, on the property subject to his control, operational maintenance and repair practices, that will ensure that the landing area and approaches are free from hazards to the operation of aircraft.
 - E) Furnish the Division, upon request, with information concerning aircraft using the seaplane base as an operating base, persons

exercising managerial or supervisory functions at the seaplane base, accidents, and the nature and extent of aeronautical activity occurring at the seaplane base.

Section 14.640 Restrictions on Use

For restrictions on use see Section 14.Appendix D, Table A.

SUBPART G: RESTRICTED LANDING AREAS

Section 14.700 Restricted Landing Area Classification

Restricted Landing Areas (RLAs) shall be classified as private-use only. For the purposes of this Subpart G, the word RLA includes RLAs utilizing aircraft having STOL capabilities. An RLA shall provide a landing area sufficient for a safe operation, taking into consideration the type of aircraft to be used and the skill level of the pilots using the RLA. The minimum standards for the establishment, management or operation of RLAs shall be in accordance with this Subpart G, including the minimum dimensional standards as shown in Section 14.Appendix E, Illustrations A and B.

Section 14.710 Application for Certificate of Approval

- a) New RLAs. The Division will issue a Certificate of Approval for an RLA in accordance with Section 14.115, and, taking into consideration:
 - 1) the RLA's proposed location;
 - 2) the RLA's size and layout;
 - 3) the relationship of the proposed RLA to the then current State and Federal Airport and Airways System;
 - 4) whether there are safe areas available for expansion purposes;
 - 5) whether the adjoining areas are free from obstructions based on a proper glide ratio;
 - 6) the nature of the terrain;
 - 7) the nature of the uses to which the proposed RLA will be put;
 - 8) the possibilities for future development; and
 - 9) the minimum standards contained in this Subpart G, including Section 14.Appendix E, Illustrations A and B. (See Section 48 of the Act.)
- b) Transfer of Certificate of Approval. The Division will issue a new Certificate of Approval for the transfer of an RLA in accordance with Section 14.120(a).
- c) Modification of Certificate of Approval. The Division will issue a new Certificate of Approval after completion of an RLA extension or alteration that requires a modification of the Certificate of Approval in accordance with Section 14.120(b).

Section 14.720 Design and Layout Requirements

The minimum RLA design and layout requirements shall be in accordance with the standards and limitations shown in Section 14.Appendix E, Illustrations A and B.

Section 14.730 Obstructions

Minimum RLA obstruction clearance standards shall be in accordance with Section 14.Appendix E, Illustration A. In order for an RLA to be eligible for a Certificate of Approval under this Part, an RLA must initially and continually be free of obstructions (e.g., trees, power lines) on all runways or landing strips within the glide ratio and height limitations shown in Section 14.Appendix E, Illustration A.

Section 14.740 Facilities

Every RLA shall provide:

- a) Wind direction/velocity indicator (must be lighted for night use); and
- b) Clearly marked thresholds and/or displaced thresholds visible from 1500' above ground level (AGL) as shown in Section 14.Appendix E, Illustration C.

Section 14.750 Responsibility of a Restricted Landing Area Certificate Holder

The holder of a Certificate of Approval for an RLA or his authorized agent has the responsibility to enforce applicable federal, State and local aeronautical laws, and regulations of this Part. In addition to maintaining the terms and conditions outlined in the Certificate of Approval and its supporting Order, the Certificate Holder or his agent must:

- a) Immediately designate any condition that may render an aircraft landing or takeoff hazardous by prominently displaying an "X" as set forth in Section 14.Appendix E, Illustration D.
- b) Supervise or cause the supervision of all aeronautical activity in connection with the RLA in the interest of safety.
- c) Maintain the landing area and approaches so as to permit safe operation in accordance with original certification standards.
- d) Ensure that the RLA has a phone number by which Division personnel can reach the Certificate Holder or his designee. In the event that the Certificate Holder or his designee is not available at this number, a reliable secondary number where the Certificate Holder or his designee can be reached shall be available. It is mandatory that any change in Certificate Holder/designee address or phone number be reported to the Division in writing, by phone or e-mail at the address provided in Section 14.115(a), within 10 days after the change.
- e) Furnish the Division, upon request, with information concerning aircraft using the RLA as an operating base, persons exercising managerial or supervisory functions at the RLA, accidents and the nature and extent of aeronautical activity occurring at the RLA.
- f) Obliterate all signs and markings that might indicate that the RLA is still operating as such, prior to the Division issuing an Order closing the RLA, in accordance with Section 14.120(c).

Section 14.760 Fly-In Events, Prevention of Accidents Due to Overcrowding of Landing Areas

- a) Whenever a fly-in event (more than six aircraft) is staged or held at any RLA, it shall be the responsibility of the Certificate Holder to:
 - 1) Provide, install, display and maintain clearly visible "Closed Runway" X markers, in accordance with Section 14.Appendix E, Illustration D (each of the four arms of each such X marker must be at least 60 feet long and at least 10 feet wide and of a color (preferably yellow) to contrast with the background on which it is installed).
 - A) Keep X markers in place at all times during the course of the event at or near each end of each landing strip or runway, other than the active landing strip or runway, to prevent mistaken or inadvertent use for landing.
 - B) Keep X markers in place at or near each end of the active landing strip or runway when all aircraft that can be accommodated have landed; or, where field, spectator, weather conditions or departure of aircraft on the ground shall render further landing of aircraft hazardous.
 - 2) Provide personnel to guide landed aircraft to and from the aircraft parking area and provide, designate and regulate parking of aircraft, automobiles or other vehicles in a safe manner.
 - 3) Provide and designate by readily discernible markings, landing strips or runways and taxiing space for landings and takeoffs, and aircraft movement on the ground during the course of the event. Landing strips or runways and taxiing space must be kept clear of persons, vehicles, animals and aircraft on the ground that are not taking off, landing or taxiing. In the event that any landing strip or runway, and any taxiing space, shall be approximately parallel, there shall be a clear minimum distance of 100 feet between their adjacent edges. Participating aircraft shall not be permitted to park closer than 100 feet to the edge-designating marker of a landing strip or runway used or designated for such use during the course of the event.
- b) It shall be the responsibility of the pilot of each aircraft participating in a fly-in event to look for and abide by:

- 1) any restrictions displayed;
- 2) "Closed Runway" X markers; and
- 3) all taxiing and parking directions.

Section 14.770 Restrictions on Use

For restrictions on use see Section 14.Appendix F, Table A.

SUBPART H: HELIPORTS/VERTIPOINTS

Section 14.800 Helipport/Vertiport Classification

Heliports and Vertiports shall be classified as public-use or private-use. They may be designated as a Hospital Helipport, Helistop, Helipport, Vertiport or Vertistop. For purposes of this Subpart H, the word "helipport" includes vertiports, vertistops and helistops. The minimum standards for the establishment, management or operation of heliports shall be in accordance with this Subpart H, including the minimum dimensional standards shown in Section 14.Appendix G, Illustrations A, B and C and Section 14.Appendix H, Table A.

Section 14.810 Application for Certificate of Approval

- a) New Heliports. The Division will issue a Certificate of Approval for a heliport in accordance with Section 14.115, and, taking into consideration:
 - 1) the heliport's proposed location;
 - 2) the heliport's size and layout;
 - 3) the relationship of the proposed heliport to the then current State and Federal Airport and Airways System;
 - 4) whether there are safe areas available for expansion purposes;
 - 5) whether the adjoining areas are free from obstructions based on a proper glide ratio;
 - 6) the nature of the terrain;
 - 7) the nature of the uses to which the proposed heliport will be put;
 - 8) the possibilities for future development; and
 - 9) the minimum standards contained in this Subpart H, including Section 14.Appendix G, Illustrations A, B and C and Section 14.Appendix H, Table A. (See Section 48 of the Act.)
- b) Transfer of Certificate. The Division will issue a new Certificate of Approval for the transfer of a heliport in accordance with Section 14.120(a).
- c) Modification of Certificate of Approval. The Division will issue a new Certificate of Approval after completion of a heliport extension or alteration that requires a modification to the Certificate of Approval in accordance with Section 14.120(b). For purposes of this Section the phrase, "extension or alteration" shall include the following:
 - 1) physical relocation of the FATO by more than 100' laterally or 25' vertically from the original certificated location;
 - 2) change in any approach/takeoff path by more than 30 degrees; or

- 3) construction of one or more additional FATOs or TLOFs. (See Section 47 of the Act.)

Section 14.820 Design and Layout Requirements

Every heliport is required to have two defined approach/takeoff paths a minimum of 90° apart. Minimum heliport design and layout requirements shall be in accordance with the standards and limitations shown in Section 14.Appendix G, Illustrations A, B and C, and described in Section 14.Appendix H, Table A.

Section 14.830 Obstructions

Minimum heliport obstruction clearance standards shall be in accordance with Section 14.Appendix G, Illustration D. In order to be eligible for a Certificate of Approval under this Part, a heliport must initially and continually be free of obstructions (e.g., power poles, trees, fencing, etc.) on all approach/takeoff paths within the glide ratio and height limitations shown in Section 14.Appendix G, Illustration D.

Section 14.840 Heliport Marking

Every heliport shall be marked so that the usable landing area is clearly defined as observed from an altitude of 500' AGL, in accordance with Section 14.Appendix G, Illustrations E, F and G.

Section 14.850 Facilities

Every heliport shall provide at least the minimum facilities as prescribed in Section 14.Appendix H, Table B.

Section 14.860 Responsibility of a Public-Use Heliport Certificate Holder

The holder of a Certificate of Approval for a public-use heliport, or his authorized agent, has the responsibility to enforce applicable federal, State and local aeronautical laws, and regulations of this Part. In addition to maintaining the terms and conditions outlined in the Certificate of Approval and its supporting Order, the Certificate Holder or his agent must:

- a) Immediately designate any condition that may render an aircraft landing or takeoff hazardous by displaying prominently a contrasting "X" over the FATO/TLOF, that is visible from a minimum of 500' AGL, and notify the appropriate FAA-FSS.
- b) Supervise or cause the supervision of all aeronautical activity in connection with, and in conformity with, the limitations prescribed in this Subpart H for a heliport.
- c) Have authorized personnel in attendance at the heliport at all times during published business hours (excluding helistops). In the event that it is impractical to comply with the foregoing, the Certificate Holder or his agent shall post a prominent notice of the existing situation and provide a telephone number for assistance.
- d) Ensure that the heliport has a phone number by which Division personnel can reach the Certificate Holder or his designee. In the event that the Certificate Holder or his designee is not available at the heliport number, an answering device at the heliport number shall provide a message identifying a reliable secondary number where the Certificate Holder or his designee can be reached. It is mandatory that any change in Certificate Holder/designee address or phone number be reported to the Division in writing, by phone or e-mail at the address provided for in Section 14.115(a), within 10 days after the change.
- e) Prescribe local heliport rules that will be reviewed and approved, prior to their adoption, by the Division.
- f) Develop and follow, on the property subject to his control, operational maintenance and repair practices, that will ensure that the landing area and approaches are free from hazards to the operation of aircraft.
- g) Furnish the Division, upon request, information concerning aircraft using the heliport as an operating base, persons exercising managerial or supervisory functions at the heliport, accidents, and the nature and extent of aeronautical activity occurring at the heliport.

- h) Obliterate all signs and markings that might indicate that the heliport is still operating, prior to the Division issuing an Order closing the heliport, in accordance with Section 14.120(c).

Section 14.870 Responsibility of a Private-Use Heliport, Restricted Landing Area Heliport, and Hospital Heliport Certificate Holder

The holder of a Certificate of Approval for a private-use heliport, restricted landing area heliport or hospital heliport, or his authorized agent, has the responsibility to enforce applicable federal, State and local aeronautical laws, and regulations of this Part. In addition to maintaining the terms and conditions outlined in the Certificate of Approval and its supporting Order, the Certificate Holder or his agent must:

- a) Immediately designate any condition that may render an aircraft landing or takeoff hazardous by displaying prominently a contrasting "X" over the FATO/TLOF, that is visible from a minimum of 500' AGL.
- b) Supervise or cause the supervision of all aeronautical activity in connection with the heliport in the interest of safety.
- c) Ensure that the heliport has a phone number by which Division personnel can reach the Certificate Holder or his designee. In the event that the Certificate Holder or his designee is not available at the heliport number, an answering device at the heliport number shall provide a message identifying a reliable secondary number where the Certificate Holder or his designee can be reached. It is mandatory that any change in Certificate Holder/designee address or phone number be reported to the Division in writing, by phone or e-mail at the address provided in Section 14.115(a), within 10 days after the change.
- d) Prescribe local heliport rules that will be reviewed and approved, prior to their adoption, by the Division.
- e) Develop and follow, on the property subject to his control, operational maintenance and repair practices, that will ensure that the heliport and approaches are free from hazards to the operation of aircraft.
- f) Furnish the Division, upon request, with information concerning aircraft using the heliport as an operating base, persons exercising managerial or supervisory functions at the heliport, accidents, and the nature and extent of aeronautical activity occurring at the heliport.
- g) Obliterate all signs and markings that might indicate that the heliport is still operating, prior to the Division issuing an Order closing the heliport, in accordance with Section 14.120(c).

Section 14.880 Restrictions on Use

For restrictions on use see Section 14.Appendix H, Table C.

SUBPART I: SPECIAL PURPOSE AIRCRAFT

Section 14.900 Special Purpose Aircraft Designation

The following aircraft are designated as Special Purpose Aircraft:

- a) Seaplanes, non-conventional type of aircraft such as lighter-than-air aircraft, or manned balloons.
- b) Sailplanes, gliders and other powerless, heavier-than-air aircraft.
- c) Agricultural aircraft during the time they are being used solely for agricultural aerial applications.
- d) Helicopters/VTOL Aircraft.
- e) Any other aircraft as designated by the Division.

Section 14.910 Registration of Special Purpose Aircraft

- a) It shall be unlawful for any person to operate an aircraft designated as a Special Purpose Aircraft, under Section 14.900, to or from an uncertificated area in the state of Illinois, without first receiving a Certificate of Registration as a Special Purpose Aircraft from the Division. Application shall be made on forms prescribed by the Division, and shall include the name of the owner of the certificated area to be used for the Special Purpose Aircraft. Additionally, any other supporting information and documentation, as may be required from time to time by the Division for the registration of a Special Purpose Aircraft under Section 14.900, shall be submitted to the Division with the application. No aircraft shall be considered a Special Purpose Aircraft until the Division has issued a Certificate of Registration to the owner of the aircraft. The Certificate of Registration shall be carried in the Special Purpose Aircraft at all times while it is being operated in the State of Illinois as a Special Purpose Aircraft. (See Section 47 of the Act.)
- b) The certificate of registration is non-transferable either as to the applicant or the aircraft and authorizes only those uses proposed in the application. The certificate shall be valid for as long as the applicant owns the aircraft identified in the application, provided the aircraft's Federal Aircraft Certificate is properly registered annually with the State of Illinois in accordance with Subpart B.

Section 14.920 Exemption from Registration

Aircraft designated as Special Purpose Aircraft under the provisions of Section 14.900, that are owned by non-residents and based outside the State of Illinois, are exempt from the Special Purpose Aircraft registration requirements provided the aircraft complies with all other applicable Sections of this Subpart I, except Section 14.930.

Section 14.930 Compliance with Aircraft Registration

Regardless of any other provisions in this Subpart I, no aircraft shall be designated as a Special Purpose Aircraft unless the aircraft is properly registered with the Division, in accordance with Subpart B, as required by the Act. (See Section 43 of the Act.)

Section 14.940 Liability

The pilot-in-command and/or owner of a Special Purpose Aircraft, operating to or from an uncertificated area shall be responsible for, and by so operating shall assume, the responsibility for any liability that may arise out of these operations. This Part shall not be interpreted as, nor does it give the pilot-in-command of the aircraft the right to trespass upon the property of another. The foregoing does not relieve a property owner from liability to invitees for damage arising from defects for which they have actual or constructive knowledge.

Section 14.950 Special Purpose Aircraft Operations

- a) Gliders/Sailplanes. Gliders/Sailplanes may utilize an uncertificated area for landings, but are expressly prohibited from taking off from an uncertificated area.
- b) Balloons. Manned balloons and other lighter-than-air aircraft, properly registered with the Division, may operate within the state of Illinois from uncertificated areas provided the pilot-in-command and/or the owner adheres to all of the requirements contained in this Part. Further, balloons, their pilots and/or owners, must comply with all of the requirements of 14 CFR 91, effective October 1, 2002, applicable to special purpose aircraft flight and/or operations.
- c) Helicopters/VTOL Aircraft. A helicopter cannot conduct more than 50 operations (takeoffs or landings) in a period of three consecutive months or 100 operations in a period of one year from the same uncertificated area. The same uncertificated area shall not be used for more than one year. An uncertificated area is defined as any location within a 2000' radius of the first point of landing.

Section 14.960 Saving Clause

The registration of an aircraft as a Special Purpose Aircraft and any other provisions contained in this Part shall in no way nullify any state laws that presently prohibit the landing or takeoff of aircraft from any public highway. These restrictions shall apply to aircraft registered as Special Purpose Aircraft, except aircraft owned or operated by the United States government, the state of Illinois and political subdivisions, and aircraft being used for medical emergencies. This Subpart I is not intended to interfere with any city, village or county ordinances.

Section 14.1000 Registration for Ultralights and Ultralight Trainers

Registration of Ultralights and Ultralight Trainers (and pilots of such aircraft) with the Division is encouraged but not required.

Section 14.1010 Liability

The pilot-in-command and/or owner of an ultralight aircraft, operating to or from an uncertificated area shall be responsible for, and by so operating shall assume, the responsibility for any liability that may arise out of these operations. This Part shall not be interpreted as, nor does it give the pilot-in-command of the aircraft the right to trespass upon the property of another. The foregoing does not relieve a property owner from liability to invitees for damage arising from defects for which they have actual or constructive knowledge.

Section 14.1020 Ultralight/Ultralight Trainer Operations

- a) Ultralights. Ultralight aircraft may operate from all certificated airports in Illinois subject to the rules and/or ordinances prohibiting such operation as adopted by the airport owner. The landing and takeoff of Ultralights will be permitted in uncertificated areas anywhere except the following:
 - 1) within four nautical miles of any airport;
 - 2) within two nautical miles of a RLA; or
 - 3) within one nautical mile of a heliport; unless, a Certificate of Approval has been issued. The flight over any congested area of a city, town or settlement, or over any open-air assembly of persons is prohibited.
- b) Ultralight Trainers. The landing and takeoff of Ultralight Trainers shall be limited to airports approved for flight instruction by the Division. The flight of Ultralight Trainers over any congested area of a city, town or settlement, or over any open-air assembly of persons is prohibited.

Section 14.1030 Saving Clause

The designation of aircraft as Ultralights or Ultralight Trainers, and any other provisions contained in this Subpart J, shall in no way nullify any state laws that presently prohibit the landing or takeoff of Ultralights or Ultralight Trainers from any public highway. These restrictions shall apply to aircraft designated as Ultralights or Ultralight Trainers, except those Ultralights or Ultralight Trainers owned or operated by the United States government, the state of Illinois and political subdivisions, and Ultralights or Ultralight Trainers being used for medical emergencies. This Part shall not be interpreted nor is it intended to interfere with any city, village or county ordinances that may restrict the uncertificated area from which an Ultralight or Ultralight Trainer may takeoff and/or land within the jurisdiction of the local governmental agency.

Section 14.1100 Purpose and Applicability

- a) This Subpart serves as a guideline for the conduct of proceedings before the Division of Aeronautics. Because the Division functions under several statutes and because the procedural requirements of those statutes are not always consistent, this Subpart must be flexible and must vest significant discretion in how a proceeding is to be conducted by the Director of Aeronautics or the Administrative Law Judge ("ALJ") assigned.
- b) This Part applies only to non-contested cases such as hearings relating to the promulgation of airport hazard zoning regulations and the issuance (cf., involuntary revocation) of certificates for airports and restricted landing areas. Hearings for a "contested case", as that term is defined in the Illinois Administrative Procedure Act (IAPA) [5 ILCS 100], will be conducted in accordance with applicable requirements of the IAPA, regulations of the Illinois Department of Transportation, and procedures established by the Illinois Aeronautics Act [620 ILCS 5].

Section 14.1105 Filing of Documents

Documents required to be filed with the Illinois Department of Transportation, Division of Aeronautics, shall be filed with the Director of the Division unless an Administrative Law Judge (ALJ) is involved. If an ALJ is involved, all materials shall be filed with the ALJ. Such documents shall be deemed filed when they are actually received and accompanied by the filing fee, if one is required.

Section 14.1110 Formal Specifications

All documents filed with the Division shall be typewritten or printed. Typewritten documents shall be on strong, durable paper not larger than 8½ by 11 inches, except that tables, maps and other documents may be larger if necessary, and if folded to the size of the document to which they are attached. Text shall be double-spaced except for footnotes and long quotations, which may be single-spaced. Type smaller than elite shall not be used. The left margin shall not be less than 1½ inches and all other margins at least one inch. If the document is bound, it shall be bound on the left side.

Section 14.1115 Copies

- a) Unless otherwise specified, an executed original and one true copy of each document shall be filed. Copies of signed documents shall show the date and signatures appearing on the original.
- b) Copies of the Division's records may be obtained, upon written request and payment of the actual costs of copying, pursuant to the Freedom of Information Act [5 ILCS 140].

Section 14.1120 Verification of Documents

Unless otherwise required by applicable rules or regulations, every document in the nature of a pleading, including motions and answers thereto but excepting briefs and assignments of error, shall be dated, signed and verified substantially in the following form:

VERIFICATION

I have read and am familiar with the contents of the foregoing document and the attached exhibits, if any. I intend and desire that in granting or denying the relief requested, the Division shall place full and complete reliance upon the accuracy of each and every statement made in that document. I have diligently attempted to ascertain the truth of all such statements. Every statement contained in this document is true and not misleading, to the best of my knowledge and belief.

DATE: _____

SIGNATURE

Section 14.1125 Identity of Filer

All documents shall identify the name, telephone number, and post office address of the person filing the document.

Section 14.1130 Amendment of Documents

- a) A pleading may be amended prior to the filing of a responsive pleading, or if no reply is filed, prior to the publishing either of a Notice of Hearing on the subject matter of the pleading or of the Order. Thereafter, amendments may be made only with leave of the Director or the ALJ.
- b) All amendments shall be consecutively numbered, commencing with Amendment No. 1, and shall identify the document being amended.

Section 14.1135 Responsive Documents

Answers to applications, complaints, petitions, motions, or other documents or Orders instituting proceedings may be filed by any interested person. Protests or memoranda of opposition or support permitted by this Subpart may be filed in lieu of answers or combined with answers.

Section 14.1140 Service of Documents

- a) The Division. Formal complaints, Notices and Orders shall be served by the Division.
- b) The Parties. Petitions, informal complaints, motions, answers, protests and memoranda shall be served by the party filing the same on all other parties and on each person known to have a substantial interest in the proceeding. Responsive documents shall be served on all the parties.
- c) How Service may be Made. Service may be made by first class, registered, or certified mail; by electronic means (e.g., telefax), or by personal delivery.
- d) Proof of Service. Any document required to be served by this Part, shall contain a certificate of mailing or personal delivery executed by the person serving the document.
- e) Date of Service. Whenever proof of service is made, the date of mailing or the date of personal delivery shall be the date of service.

Section 14.1145 Appearances

- a) Who May Appear. Any party to a proceeding may appear and be heard in person or by attorney. A corporation, association, or public body or agency (including the Division) may appear and present evidence by any bona fide officer, employee or representative.
- b) Right to Counsel. Any party to any proceeding governed by this Subpart K may be accompanied, represented and advised by counsel, and may be examined by his own counsel.

Section 14.1150 Informal Participation in Hearing Cases

In any proceeding which is to be determined after Notice and hearing, any interested person may appear and present evidence which is relevant to the issues. Such evidence shall be presented in either oral or written form as the ALJ, in his sole discretion, may direct. With the consent of the ALJ, such person may cross-examine witnesses and be cross-examined and within the time fixed, submit written statements or a brief to the ALJ with respect to the issues, which shall be filed and served as required of intervenors.

Section 14.1155 Formal Participation

Any person may file an application for leave to intervene in a proceeding, which application shall show a statutory right or a substantial interest in the proceeding. A person permitted to intervene in a proceeding thereby becomes a party to the proceeding for all purposes. No decision granting or denying intervention shall be deemed to constitute an expression of the Division with respect to the substantive right of the intervenor.

Section 14.1160 Computation of Time

- a) In computing any period of time prescribed or allowed by this Subpart, Notice, Order, regulation of the Division, the ALJ, or by any applicable statute; the day of the act, event or default after which the designated period of time begins to run, is not to be included.
- b) The last day of the period so computed is to be included, unless it is a Saturday, Sunday or legal holiday for the Division, in which event the period runs until the end of the next day which is neither a Saturday, Sunday nor a legal holiday for the Division. When the period of time prescribed is seven days or less, intermediate Saturdays, Sundays and legal holidays for the Division shall be excluded in the computation.

Section 14.1165 Extensions of Time

The Division or the ALJ assigned to any proceeding may extend the time for taking any action, without notice, before the expiration of the prescribed period; or, on written motion, permit the act to be done after the expiration of the specified period when such action would be conducive to the ends of justice or not adverse to the public interest.

Section 14.1170 Motions

An application to the Division or the ALJ for an Order or ruling not otherwise specifically provided for shall be by written motion, except during hearing when it may be made orally. After a proceeding is assigned to an ALJ, all motions relating to procedural matters shall be addressed to the ALJ and no interlocutory appeal of his decision will be entertained. The ALJ may, in his discretion, refer any motion to the Director for decision. All motions shall be made at an appropriate time and served on all participants to the proceeding. This Section does not apply to motions for rehearing, reargument or reconsideration.

Section 14.1175 Answers to Motions

Within 10 days after a motion is served, or such other period as the Division or the ALJ may fix, a participant in the proceeding may file an answer. Replies to answers shall not be allowed, but all new matter contained in the answer shall be deemed controverted.

Section 14.1180 Subpoenas

- a) Issuance. Subpoenas for the attendance of witnesses, or for the production of books, papers, accounts or documents at a hearing in a proceeding pending before the Division may be issued by the Director or by the ALJ assigned to the proceeding, either sua sponte or on the written motion of a party showing good cause for the issuance of the subpoena.
- b) Motion. Motion for subpoenas shall be verified and shall specify the books, papers, accounts or documents desired, and the material and relevant facts to be proved by them. No subpoena shall be issued unless it is first determined that the matter sought is relevant, material and necessary, and that compliance with the subpoena will not result in harassment or undue hardship, inconvenience or expense to the party subpoenaed.
- c) Service. Service of subpoenas and payment of witness fees and expenses shall be made in the manner prescribed by the Illinois Supreme Court Rules, the Code of Civil Procedure [735 ILCS 5], and Section 47 of the Fees and Salaries Act [55 ILCS 45/47].

Section 14.1185 Administrative Law Judge (ALJ)

- a) Qualification. An ALJ must have knowledge of, and be willing to act consistent with, the policies of the Division of Aeronautics.
- b) Duties and Authority. The ALJ shall have the following powers, in addition to any other specified in this Subpart K:
 - 1) to give notice concerning and to hold hearings;
 - 2) to administer oaths and affirmations;
 - 3) to examine witnesses;
 - 4) to issue subpoenas and to take or cause depositions to be taken;
 - 5) to rule upon offers of proof and to receive relevant evidence;
 - 6) to regulate the course and conduct of the hearing;
 - 7) to determine the form in which evidence shall be submitted and the number of copies to be supplied and served;
 - 8) to hold conferences, before or during the hearing, for the settlement or simplification of issues;
 - 9) to rule on motions and to dispose of procedural requests or similar matters;
 - 10) to grant extensions of time on any matter connected with the hearing;
 - 11) to take any other action authorized by this Part, or by any Illinois aeronautics statute;
 - 12) to waive, or otherwise grant a variance from, such procedural requirements as may be helpful to avoid an impracticable or unduly harsh consequence and which would not result in harm, cost or inconvenience to other persons; and
 - 13) to rule on requests for protective Orders, which would prevent the disclosure of proprietary or personal information, whose disclosure would not be a public benefit.

Section 14.1190 Hearings

- a) Notice. The ALJ to whom the case is assigned, or the Division, shall give the parties reasonable notice of the time and place for a hearing or of the change in the date and place of a hearing and the nature of such hearing.
- b) Evidence. Evidence presented at the hearing shall be given under oath unless waived by the ALJ and shall be limited to material evidence relevant to the issues in the proceedings. Neither the Division, nor the ALJ, shall be bound by the technical rules of evidence or pleading; and, no informality in any proceeding, in the manner of content or testimony taken in a proceeding, shall invalidate any agency Order, decision or ruling made, approved or confirmed by the Division.
- c) Administrative Notice. The Division will take notice of its Orders, decisions, rules and regulations, and of any fact of which the courts and administrative agencies of the state of Illinois may take official notice.
- d) Limitation of Witnesses. The ALJ may limit the number of witnesses whose testimony is merely cumulative. The ALJ shall excuse, and remove if necessary, witnesses not offering relevant and material evidence.
- e) Construction. Rules with respect to evidence shall be applied toward the end that all needful and proper evidence shall be conveniently, inexpensively and speedily heard while preserving the substantial rights of the parties and the witnesses.
- f) Objections to Evidence. Objections to the admission or exclusion of evidence shall be in short form, stating the grounds of objections relied upon, and the transcript shall not include argument or debate thereon except as ordered by the ALJ. Rulings on such objections shall be a part of the transcript, to the extent that a transcript may exist.
- g) Exceptions. Formal exceptions to the rulings of the ALJ made during the course of the hearing are unnecessary. For all purposes for which an exception otherwise would be taken, it is sufficient that a party, at the time of the ruling of the ALJ is made or sought, makes known the action he desires the ALJ to take or his objection to an action taken, and his grounds therefor.
- h) Offers of Proof. Any offer of proof made in connection with an objection taken to any ruling of the ALJ, rejecting or excluding proffered oral testimony, shall consist of a statement of the substance of the evidence, which counsel contends would be adduced by such testimony; and, if the excluded evidence consists of evidence in documentary or written form, or reference to documents or records, a

copy of such evidence shall be marked for identification and shall constitute the offer of proof.

- i) Substitution of Copies for Original Exhibits. In his discretion, the ALJ may permit a party to withdraw original documents offered in evidence and substitute true copies in lieu thereof.
- j) Record of Hearings. The ALJ shall determine whether the hearing shall be recorded electronically or whether a reporter shall record and prepare a transcript of the hearing. The ALJ shall make necessary arrangements for recording the hearing. If the record is made electronically, the unaltered tape or other recording medium shall be kept for three years. The tape shall be transcribed when the Division determines that it is necessary to do so (for example, for an appeal). The failure to have a stenographer prepare a transcript shall not invalidate a hearing.
- k) Corrections to Transcript. Changes in the official transcript may be made only when errors affecting substance are found. A motion to correct a transcript may be filed within 10 days after notice of the official transcript is sent to a party and before an Order is entered. If no objection is received, the transcript shall be automatically corrected. If an objection is received, the ALJ shall enter an Order on the motion.
- l) Briefs and Arguments. The ALJ may permit oral argument to be presented to him at the close of the hearing. Briefs and written argument may be submitted to him, if permitted by him in his discretion, and within the time prescribed by him. Copies of briefs and written arguments shall be served on all parties.

Section 14.1195 Petition for Rehearing

Within thirty days after the service of any ruling, Order or decision of the Division based upon a hearing, any party or person affected thereby may apply for a rehearing thereof in respect of any matter connected therewith specified in such application for rehearing. Petitions for rehearing shall be in writing, and shall state specifically the grounds relied upon for such rehearing, and shall be accompanied by proof of service thereof upon all the parties and persons affected thereby.

Section 14.1196 Administrative Review

Final decisions of the Division may be appealed in accordance with the Administrative Review Law [735 ILCS 5/Art III].

Section 14.APPENDIX A Airport Standards

Section 14.ILLUSTRATION A Airports (Public- or Private-Use) Minimum Dimensional Standards

PLAN VIEW

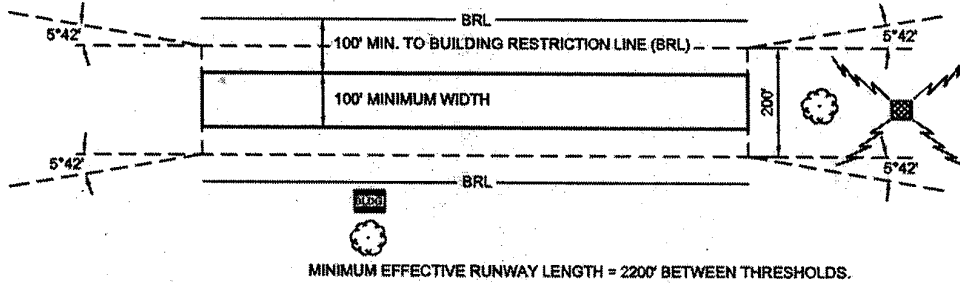

PROFILE (END) VIEW - OBSTRUCTION CLEARANCE

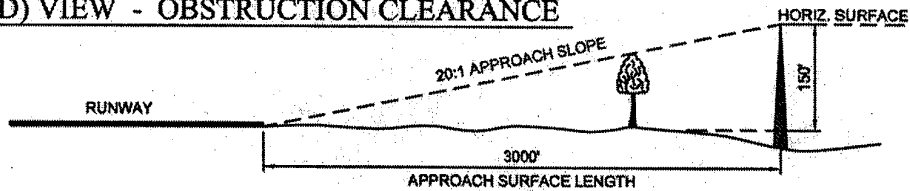

RUNWAY CROSS SECTION - OBSTRUCTION CLEARANCE

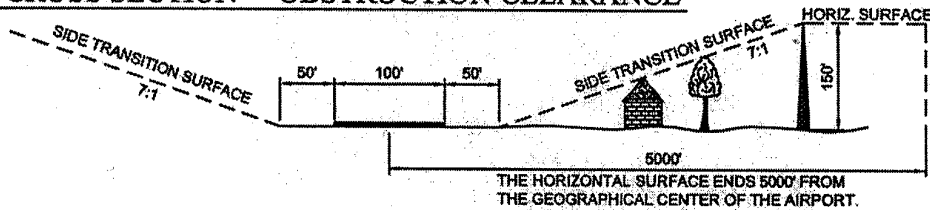

- NOTES:
1. NO PENETRATIONS TO 7:1 SIDE TRANSITION SURFACES.
 2. NO PENETRATIONS TO 20:1 RUNWAY APPROACHES.
 3. NO CROPS WITHIN 100' EITHER SIDE OF RUNWAY CENTER LINE.
 4. CLEARANCES REQUIRED FOR APPROACHES
 - 10' CLEARANCE OVER ALL PRIVATE ROADWAYS.
 - 15' CLEARANCE OVER ALL PUBLIC HIGHWAYS.
 - 17' CLEARANCE OVER ALL INTERSTATE HIGHWAYS.
 - 23' CLEARANCE OVER ALL RAILROADS.

SECONDARY RUNWAYS: UNLESS DESIGNATED AS STOL, SECONDARY RUNWAYS ARE RECOMMENDED TO BE AT LEAST 80% OF THE EFFECTIVE LENGTH OF THE PRIMARY RUNWAY.

Section 14.APPENDIX A Airport Standards

Section 14.ILLUSTRATION B Airports (Public- or Private-Use) Minimum Separation & Gradient Standards

PROFILE VIEW - MINIMUM STANDARDS FOR SEPARATION

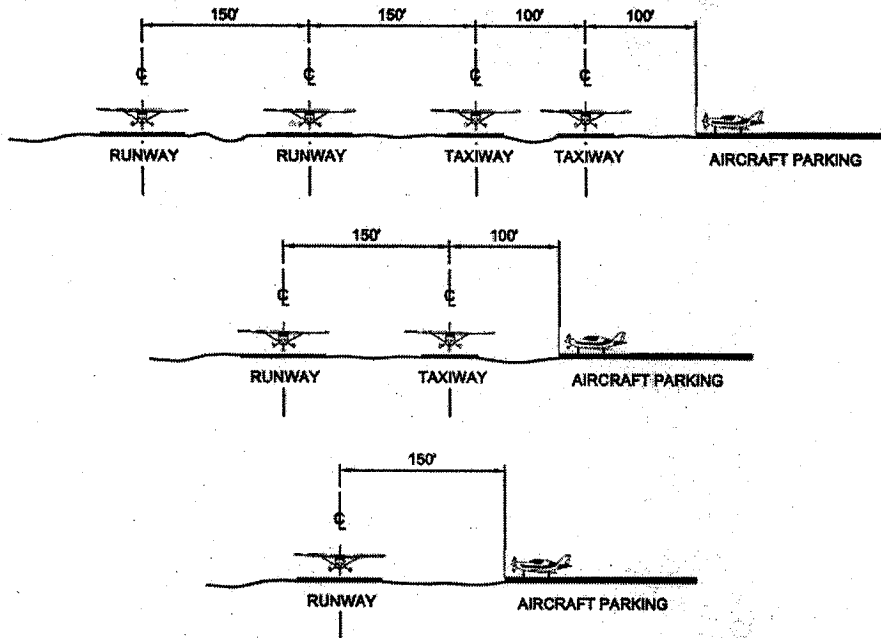

RUNWAY GRADIENT

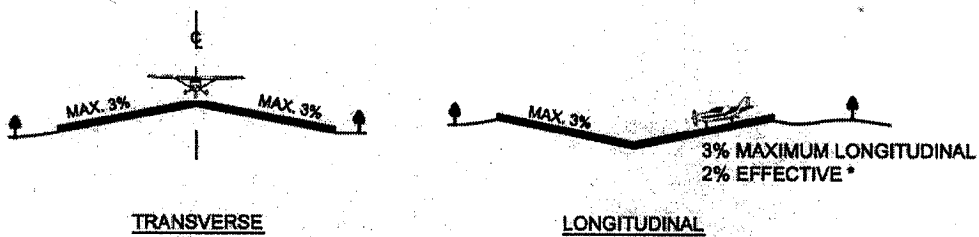

• EFFECTIVE RUNWAY GRADIENT = $\frac{\text{MAXIMUM DIFFERENCE IN RUNWAY END ELEVATIONS}}{\text{RUNWAY LENGTH}}$

Section 14.APPENDIX A Airport Standards

Section 14.ILLUSTRATION C Ultralight/STOL Airports (Public- or Private-Use)
Minimum Dimensional Standards

PLAN VIEW

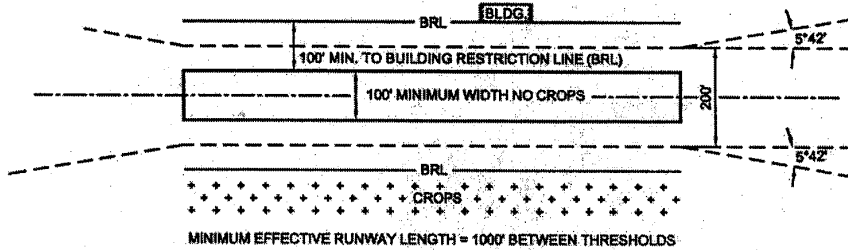

PROFILE (END) VIEW - OBSTRUCTION CLEARANCE

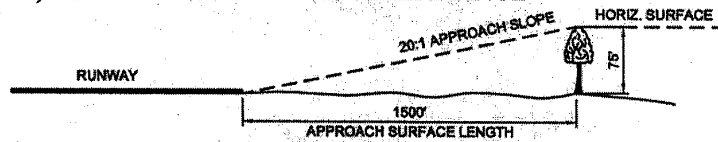

NOTE: THE MINIMUM EFFECTIVE LENGTH OF A RUNWAY IS THE AMOUNT OF LANDING LENGTH REMAINING AFTER ANY DISPLACEMENT ON THAT PARTICULAR RUNWAY END.

RUNWAY CROSS SECTION VIEW - OBSTRUCTION CLEARANCE

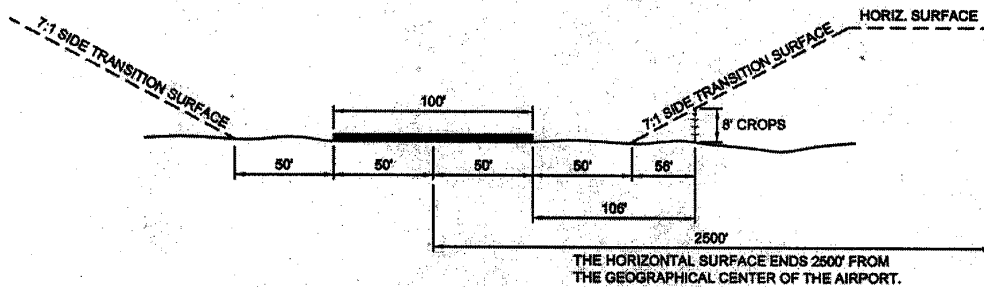

- NOTES:
1. NO PENETRATIONS TO 7:1 SIDE TRANSITION SURFACES.
 2. NO PENETRATIONS TO 20:1 RUNWAY APPROACHES.
 3. NO CROPS WITHIN 100' EITHER SIDE OF RUNWAY CENTER LINE.
 4. CLEARANCES REQUIRED FOR APPROACHES
 - 10' CLEARANCE OVER ALL PRIVATE ROADWAYS.
 - 15' CLEARANCE OVER ALL PUBLIC HIGHWAYS.
 - 17' CLEARANCE OVER ALL INTERSTATE HIGHWAYS.
 - 23' CLEARANCE OVER ALL RAILROADS.

Section 14.APPENDIX A Airport Standards

Section 14.ILLUSTRATION D Ultralight/STOL Airports (Public- or Private-Use)
Minimum Separation & Gradient Standards

PROFILE VIEW - MINIMUM STANDARDS FOR SEPARATION

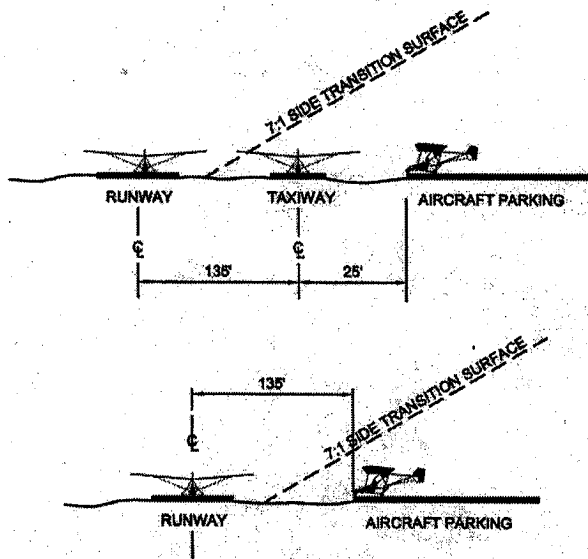

RUNWAY GRADIENT

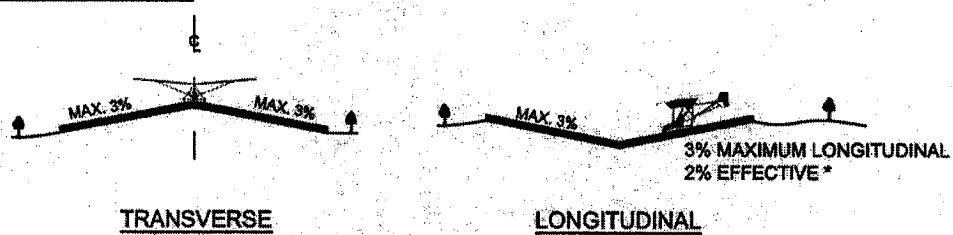

* EFFECTIVE RUNWAY GRADIENT = $\frac{\text{MAXIMUM DIFFERENCE IN RUNWAY END ELEVATIONS}}{\text{RUNWAY LENGTH}}$

Section 14.APPENDIX A Airport Standards

Section 14.ILLUSTRATION E Airports (Public- or Private-Use) Line of Sight

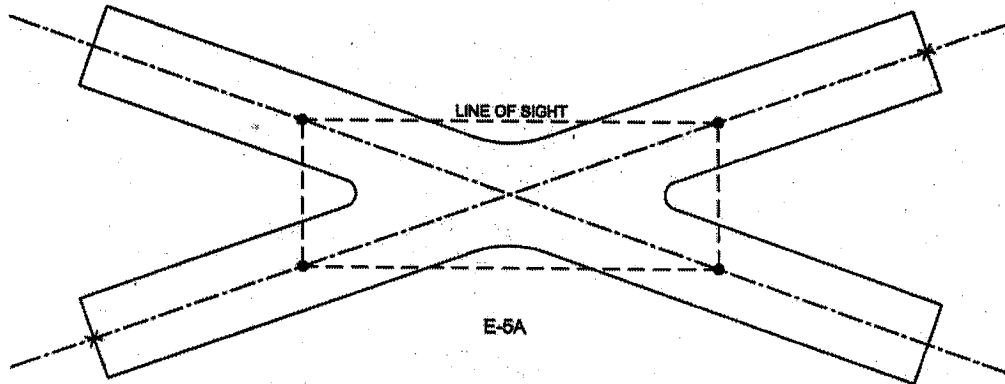

NOTE: LINE OF SIGHT MUST BE MAINTAINED BETWEEN THE MIDPOINTS OF THE COMMON RUNWAY INTERSECTIONS AND THE RUNWAY THRESHOLDS.

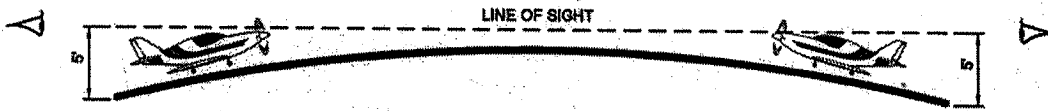

LONGITUDINAL LINE OF SIGHT BETWEEN ENDS OF SAME RUNWAY.

E-5B

Section 14.APPENDIX A Airport Standards

Section 14.ILLUSTRATION F Airports (Public- or Private-Use) Visual Runway Markings

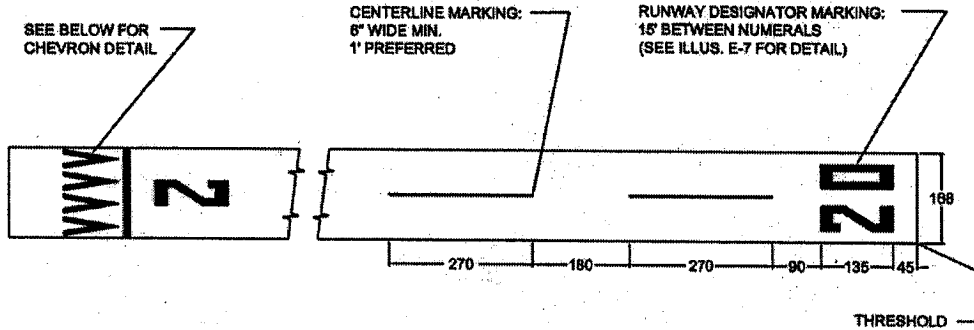

Chevron and Arrow Detail

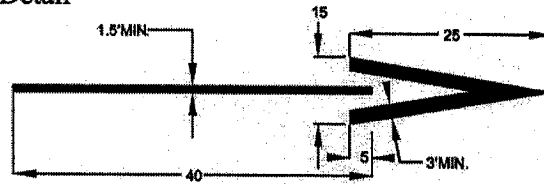

Displaced Threshold Example

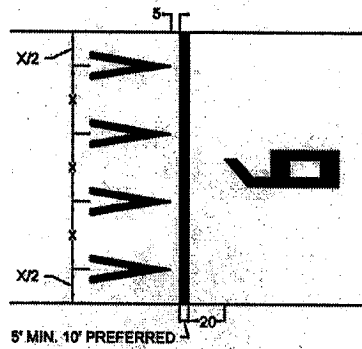

FOUR CHEVRONS PLACED SYMMETRICALLY ABOUT THE RUNWAY CENTERLINE WITH UNIFORM LATERAL SPACING AS INDICATED.
"X" = (RUNWAY WIDTH) ÷ 4

Section 14.APPENDIX A Airport Standards

Section 14.ILLUSTRATION G Airports (Public- or Private-Use) Numerals Detail

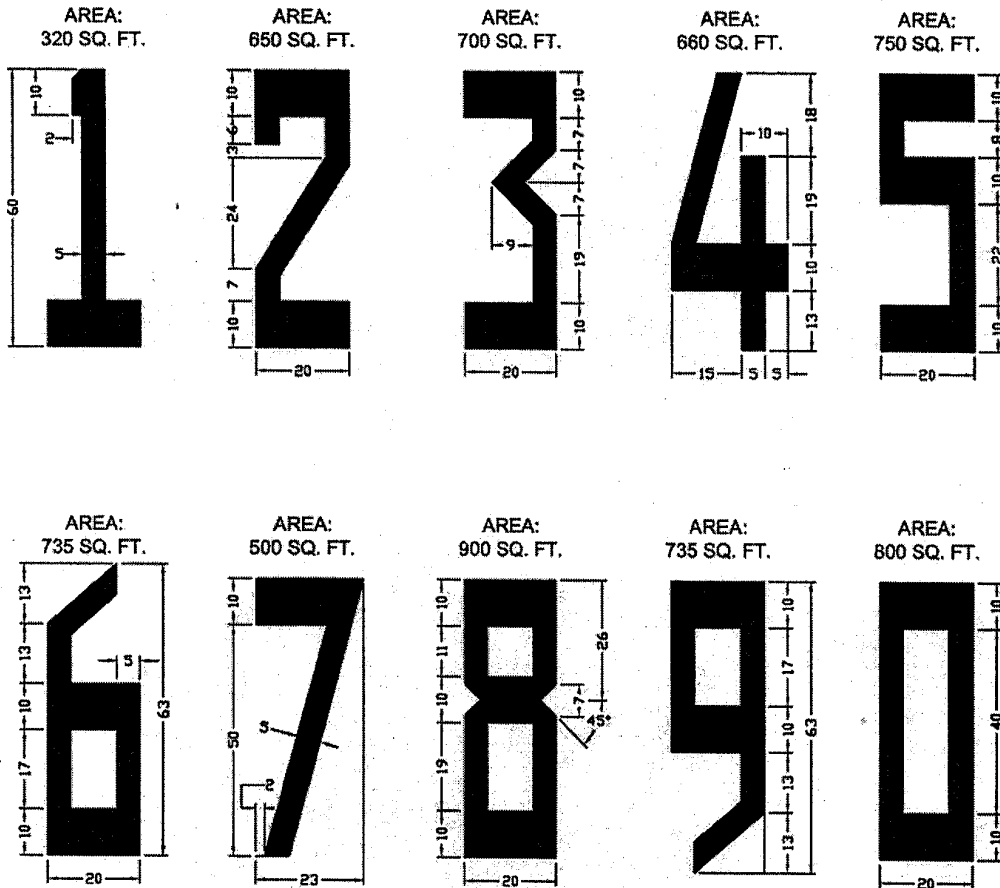

NOTE:
NORMAL SPACING BETWEEN NUMERALS = 15'

FOR RUNWAYS LESS THAN 75' WIDE:
TAKE DIMENSIONS AND MULTIPLY BY .75
ALLOW AT LEAST 10 FEET BETWEEN NUMERALS IF POSSIBLE

Section 14.APPENDIX A Airport Standards

Section 14.ILLUSTRATION H Airports and Non-Standard Traffic Patterns (Public- or Private-Use) Segmented Circle Detail

Segmented Circle Detail

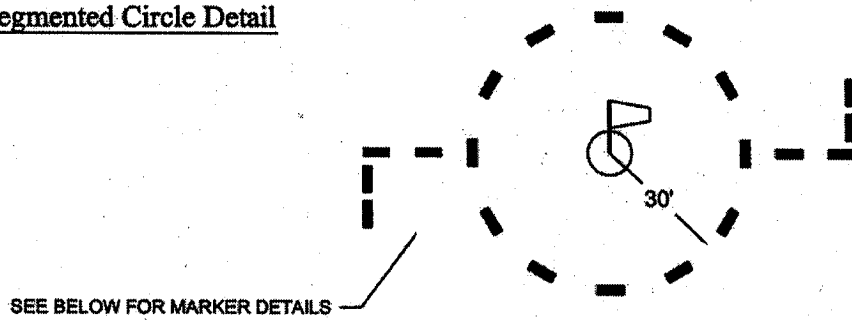

Marker and Traffic Arm Detail

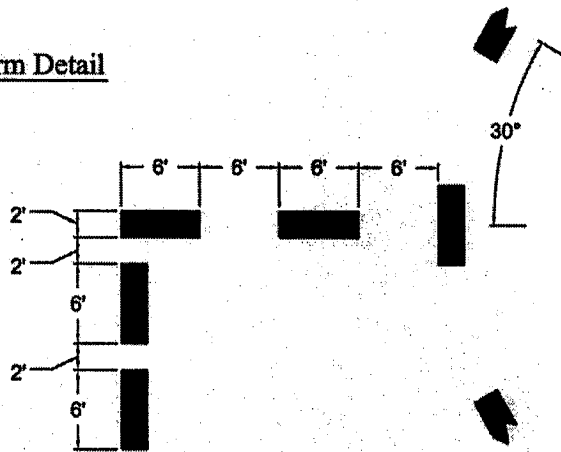

MARKERS CAN BE WHITE PAINTED CONCRETE, CONCRETE BLOCKS, TIRES, WHITE ROCK, ETC.

Section 14.APPENDIX A Airport Standards

Section 14.ILLUSTRATION I Airports (Public- or Private-Use) Displaced Threshold Markings

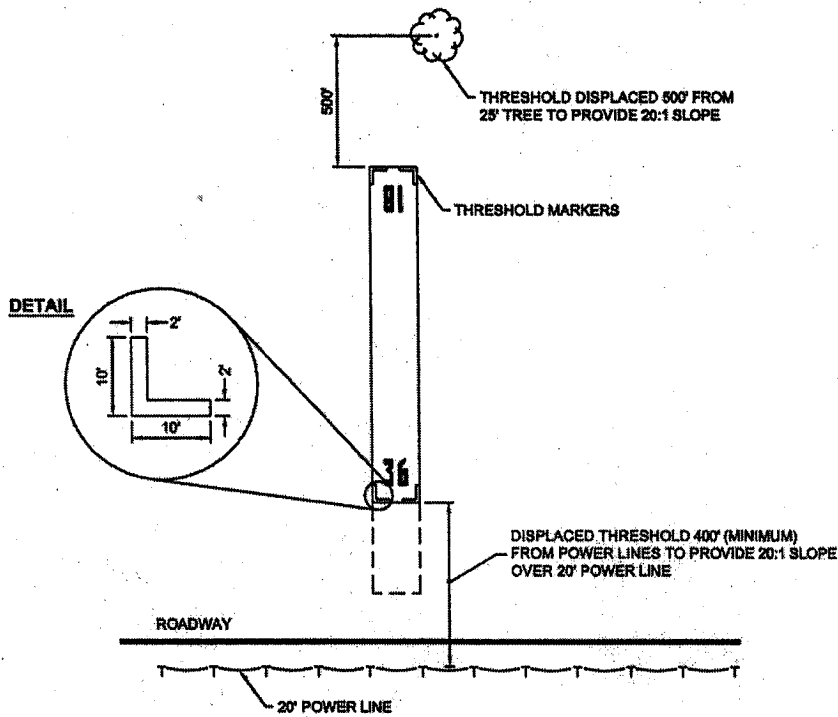

NOTE: MEASURE THE LEGS 10' LONG BY 2' WIDE. CUT A TRENCH 4" TO 6" DEEP. PUT SHEET PLASTIC IN THE BOTTOM AND FILL WITH CRUSHED WHITE ROCK OR OTHER DISTINGUISHABLE MATERIAL.

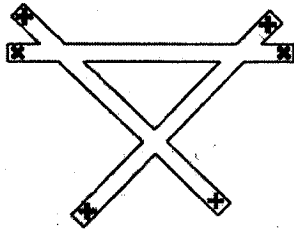
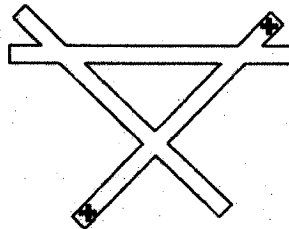
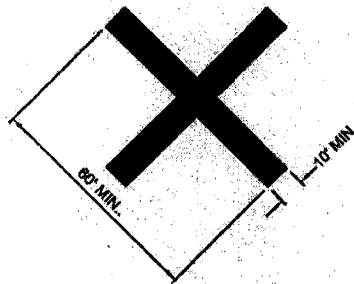
Section 14.APPENDIX A Airport Standards**Section 14.ILLUSTRATION J Airports (Public- or Private-Use) Closed Airport and Closed Runway Marker**ENTIRE AIRPORT CLOSEDONE RUNWAY CLOSEDDETAIL OF CLOSED AIRPORT AND RUNWAY MARKER**GENERAL NOTES**

1. THE MARKER SHOULD BE CONSTRUCTED OF DURABLE WATERPROOF MATERIAL AND IT SHOULD BE NO SMALLER THAN SHOWN IN THE DETAIL. IN AREAS WHERE SNOW IS EXPECTED THE MARKER SHOULD BE CONSTRUCTED SO THAT IT WILL SHED SNOW.
2. COLOR OF MARKER MATERIAL (NATURAL OR APPLIED) SHOULD PROVIDE MAXIMUM CONTRAST WITH BACKGROUND AREAS. (YELLOW OR WHITE RECOMMENDED)
3. THE MARKER SHOULD BE INSTALLED AT A SUITABLE HEIGHT ABOVE THE GROUND TO PREVENT IT FROM BECOMING OBSCURED BY VEGETATION, WATER, OR EARTH.
4. WHERE A PAVED RUNWAY IS CLOSED, THE MARKER MAY BE PAINTED ON THE RUNWAY PROVIDED IT WILL NOT BECOME OBSCURED AS NOTED ABOVE.

Section 14.APPENDIX B Airport Facility Requirements and Restrictions on Use**Section 14.TABLE A Facility Requirements**

Item	Airports Public-Use	Airports Private-Use	Ultralight/STOL Airports Public-Use	Ultralight/STOL Airports Private-Use
24-Hour Phone	Required	Recommended	Required	Not Required
Access Control a) Spectator b) Vehicular c) Perimeter	Required Required Not Required (Encouraged)	Recommended Recommended Recommended	Required Required Not Required (Encouraged)	Recommended Recommended Recommended
Segmented Circle Marker where a non- standard traffic pattern is used. ¹	Required	Required	Required	Required
Fire Protection	Required - one 20# extinguisher, two where fueling is present.	Recommended	Required	Recommended
First-Aid Kit	Required	Recommended	Required	Recommended
Fuel Sales	Required during normal business hours. Available by phone after business hours.	Not Required	Recommended during normal business hours.	Not Required
Hangar/Office Access	Required during normal business hours.	Not Required	Recommended during normal business hours.	Not Required
Potable Water	Required	Recommended	Required	Recommended
Runway Lights	Required for night use.	Required for night use.	Required for night use.	Required for night use.
Sanitary Restroom	Required during normal business hours. Available by phone after business hours.	Recommended	Required during normal business hours. Available by phone after business hours.	Recommended

Item	Airports Public-Use	Airports Private-Use	Ultralight/STOL Airports Public-Use	Ultralight/STOL Airports Private-Use
Tie-Down Facilities	Required	Recommended	Required	Recommended
Wind Direction/ Velocity Indicator (must be lighted for night use). ²	Required	Required	Required	Required

¹ Not required where 24-hour tower is in operation.

² Lighting required if runway lights are available.

Section 14.APPENDIX B Airport Facility Requirements and Restrictions on Use**Section 14.TABLE B Restrictions on Use**

Use	Airports Public-Use	Airports Private-Use	Ultralight/STOL Airports Public-Use	Ultralight/STOL Airports Private-Use
Aircraft Rental	Allowed	Allowed	Allowed	Allowed
Based Agricultural Operations	Allowed	Allowed	Allowed	Allowed
# of Based Aircraft	No restrictions	No restrictions	No restrictions on Ultralight trainers, registered Special Purpose or aircraft certificated for STOL operations.	No restrictions on Ultralight trainers, registered Special Purpose or aircraft certificated for STOL operations.
Carrying of Passengers for Hire	Allowed	Allowed	Allowed	Allowed
Commercial Maintenance	Allowed	Allowed	Allowed	Allowed
Commercial Parachute Operations	Allowed	Allowed	Take-offs Prohibited.	Take-offs Prohibited.
Flight Instruction	Unrestricted	Unrestricted	Unrestricted	Unrestricted
Fly-In Events	Allowed	Allowed	Allowed	Allowed
Through-the- Fence Operations	Allowed - license approval required by the Division.	Allowed - location and number of access points to be approved by the Division.	Allowed - location and number of access points to be approved by the Division.	Allowed - location and number of access points to be approved by the Division.
Application of De-icing Agents	Only non- corrosive de- icing agents allowed.	Only non- corrosive de- icing agents allowed.	Only non- corrosive de- icing agents allowed.	Only non- corrosive de- icing agents allowed.

Section 14.APPENDIX C Airports for Non-Conventional Aircraft Standards

Section 14.ILLUSTRATION A Airports for Non-Conventional Aircraft Minimum Dimensional Standards

BALLOON PORTS

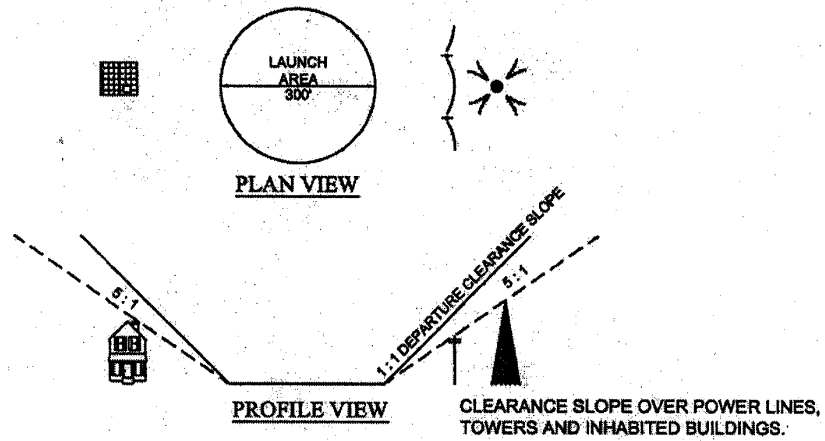

SEAPLANE BASES

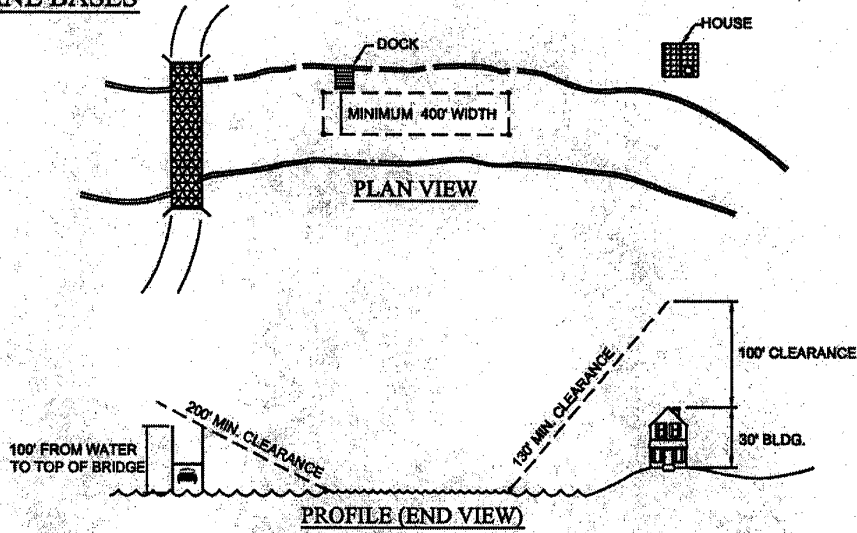

Section 14.APPENDIX D Airports for Non-Conventional Aircraft Restrictions on Use**Section 14.TABLE A Restrictions on Use**

Use	Airports for Non-Conventional Aircraft Public-Use	Airports for Non-Conventional Aircraft Private-Use
Aircraft Rental	Rental aircraft must be designated as Special Purpose or exempted aircraft.	Rental aircraft must be designated as Special Purpose or exempted aircraft.
Based Agricultural Operations	Allowed	Allowed
Based Aircraft	No restrictions on number. Must be designated as Special Purpose or exempted aircraft.	No restrictions on number. Must be designated as Special Purpose or exempted aircraft.
Carrying of Passengers for Hire	Allowed	Allowed
Commercial Maintenance	Allowed	Allowed
Commercial Parachute Operations	Allowed	Allowed
Flight Instruction	Restricted to aircraft designated in Illinois as Special Purpose unless exempted.	Restricted to aircraft designated in Illinois as Special Purpose unless exempted.
Fly-In Events	Aircraft must be designated as Special Purpose or exempted aircraft.	By personal invitation only. (Prior approval and permit required from the Division.) Restricted to Special Purpose or exempted aircraft.
Application of De-icing Agents	Only non-corrosive de-icing agents allowed.	Only non-corrosive de-icing agents allowed.

Section 14.APPENDIX E Restricted Landing Areas Standards

Section 14.ILLUSTRATION A Restricted Landing Areas Minimum Dimensional Standards

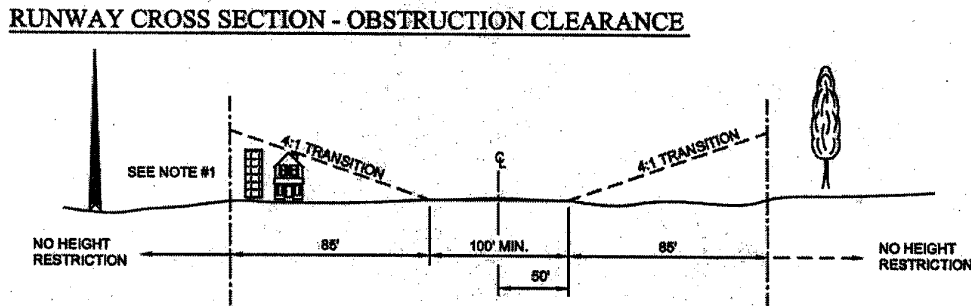
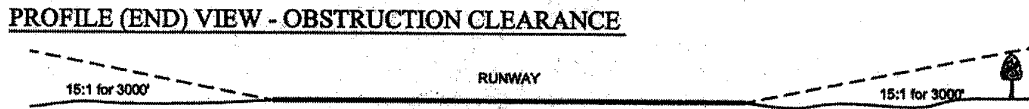
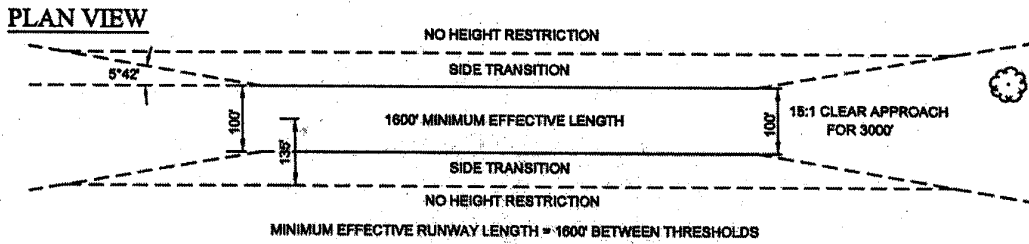

- NOTES:**
1. NO PENETRATIONS TO 4:1 SIDE TRANSITION SURFACES FOR 135' FROM CENTERLINE
 2. NO PENETRATIONS TO 15:1 RUNWAY APPROACHES.
 3. NO CROPS 50' EACH SIDE OF CENTER LINE.
 4. CLEARANCES REQUIRED FOR APPROACHES:
 - 10' CLEARANCE OVER ALL PRIVATE ROADWAYS.
 - 15' CLEARANCE OVER ALL PUBLIC HIGHWAYS.
 - 17' CLEARANCE OVER ALL INTERSTATES.
 - 23' CLEARANCE OVER ALL RAILROADS.

Section 14.APPENDIX E Restricted Landing Areas Standards

Section 14.ILLUSTRATION B Restricted Landing Areas Minimum Separation & Gradient Standards

PROFILE VIEW - MINIMUM STANDARDS FOR SEPARATION

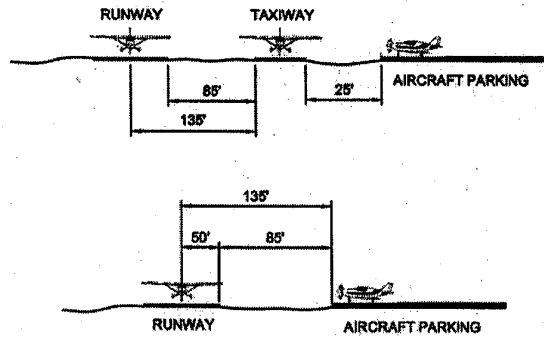

RUNWAY GRADIENT

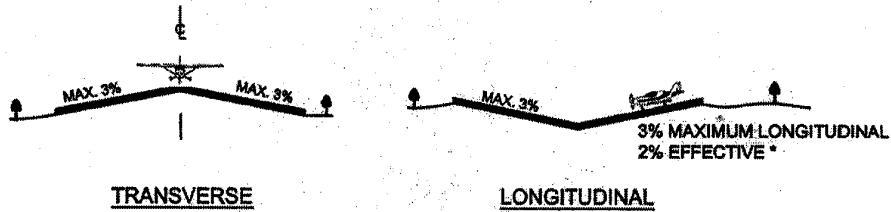

* EFFECTIVE RUNWAY GRADIENT = $\frac{\text{MAXIMUM DIFFERENCE IN RUNWAY END ELEVATIONS}}{\text{RUNWAY LENGTH}}$

Section 14.APPENDIX E Restricted Landing Areas Standards

Section 14.ILLUSTRATION C Restricted Landing Areas Displaced Threshold Markings

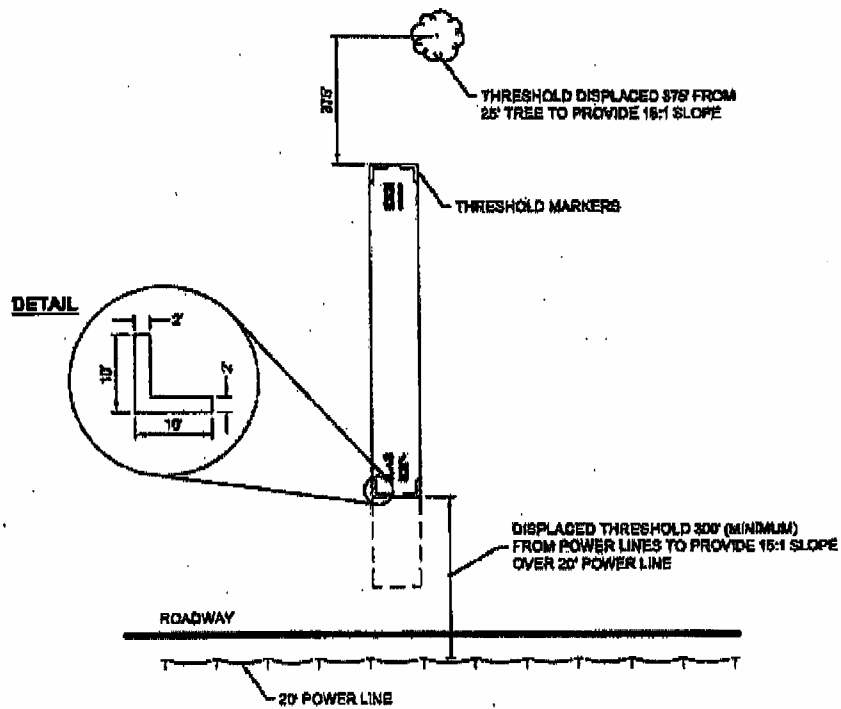

NOTE: MEASURE THE LEGS 10' LONG BY 2' WIDE. CUT A TRENCH 4" TO 5" DEEP. PUT SHEET PLASTIC IN THE BOTTOM AND FILL WITH CRUSHED WHITE ROCK OR OTHER DISTINGUISHABLE MATERIAL.

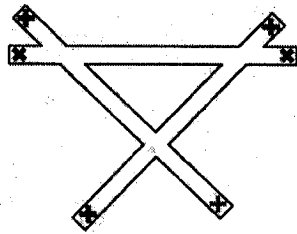
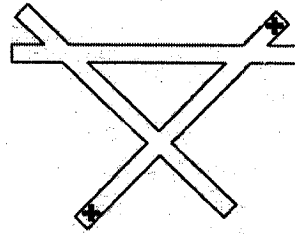
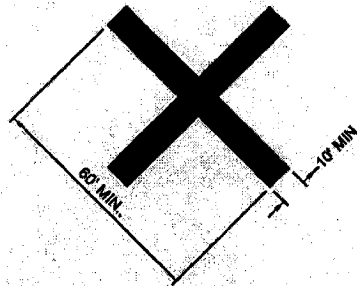
Section 14.APPENDIX E Restricted Landing Areas Standards**Section 14.ILLUSTRATION D Restricted Landing Areas Closed RLA & Closed Runway Marker**ENTIRE RLA CLOSEDONE RUNWAY CLOSEDDETAIL OF CLOSED RLA AND RUNWAY MARKERGENERAL NOTES

1. THE MARKER SHOULD BE CONSTRUCTED OF DURABLE WATERPROOF MATERIAL AND IT SHOULD BE NO SMALLER THAN SHOWN IN THE DETAIL. IN AREAS WHERE SNOW IS EXPECTED THE MARKER SHOULD BE CONSTRUCTED SO THAT IT WILL SHED SNOW.
2. COLOR OF MARKER MATERIAL (NATURAL OR APPLIED) SHOULD PROVIDE MAXIMUM CONTRAST WITH BACKGROUND AREAS. (YELLOW OR WHITE RECOMMENDED)
3. THE MARKER SHOULD BE INSTALLED AT A SUITABLE HEIGHT ABOVE THE GROUND TO PREVENT IT FROM BECOMING OBSCURED BY VEGETATION, WATER, OR EARTH.
4. WHERE A PAVED RUNWAY IS CLOSED, THE MARKER MAY BE PAINTED ON THE RUNWAY PROVIDED IT WILL NOT BECOME OBSCURED AS NOTED ABOVE.

Section 14.APPENDIX F Restricted Landing Areas Restrictions on Use**Section 14.TABLE A Restrictions on Use**

Use	Restricted Landing Area	Ultralight/STOL Restricted Landing Area
Aircraft Rental	Prohibited	Prohibited
Based Agricultural Operations	Allowed	Allowed
Based Aircraft	Maximum of six based aircraft.	No Restrictions
Carrying of Passengers for Hire	Prohibited*	Prohibited*
Commercial Maintenance	Prohibited	Prohibited
Commercial Parachute Operations	Prohibited	Prohibited
Flight Instruction	a) Restricted to immediate family of Certificate Holder (excluding certificates held by corporation). Non-continuous. b) Specialized dual instruction originating from a bona fide flight training operation based at an airport.	Prohibited
Fly-In Events (More than six Aircraft)	By personal invitation only. (Prior approval and permit required from the Division.)	By personal invitation only. (Prior approval and permit required from the Division.)
Through-the-Fence Operations	Allowed - location and number of access points to be approved by the Division (maximum of six aircraft).	Prohibited
Application of De-icing Agents	Only non-corrosive de-icing agents allowed.	Only non-corrosive de-icing agents allowed.

*Except for EMS operations.

Section 14.APPENDIX G Heliport/Vertiport Standards

Section 14.ILLUSTRATION A Public- or Private-Use Heliport/Vertiport Minimum Dimensional Standards

PLAN VIEW

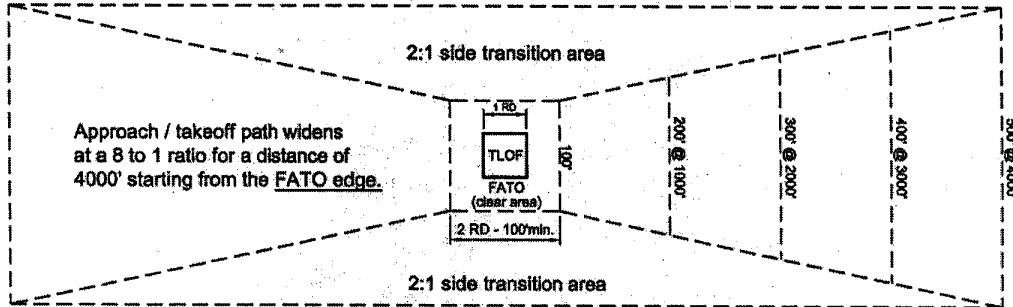

NOTE: Paths may curve to avoid obstructions or noise-sensitive areas.

PROFILE VIEW

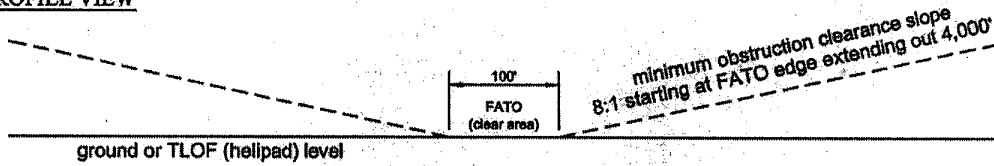

Section 14.APPENDIX G Heliport/Vertiport Standards

Section 14.ILLUSTRATION B Restricted Landing Area Heliport Minimum Dimensional Standards

WITH APPROACH / TAKEOFF PATHS 180° APART RECOMMENDED
(MINIMUM OF 90° REQUIRED)

PLAN VIEW

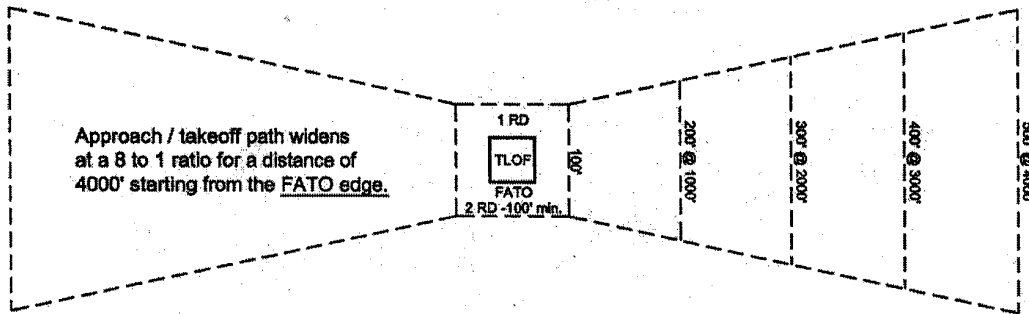

NOTE: Paths may curve to avoid obstructions or noise-sensitive areas.

PROFILE VIEW

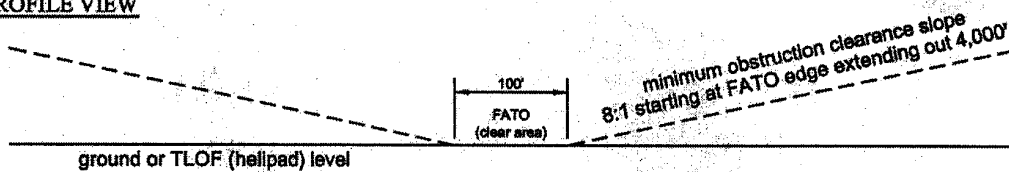

NOTE: The second approach / takeoff path may have a 5:1 slope if needed.

Section 14.APPENDIX G Heliport/Vertiport Standards

Section 14.ILLUSTRATION C Hospital Heliport Minimum Dimensional Standards

WITH APPROACH / TAKEOFF PATHS 180° APART RECOMMENDED
(MINIMUM OF 90° REQUIRED)

PLAN VIEW

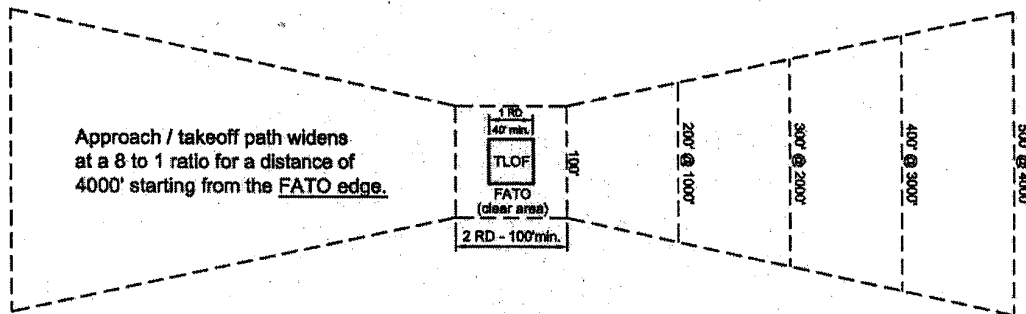

NOTE: Paths may curve to avoid obstructions or noise-sensitive areas.

PROFILE VIEW

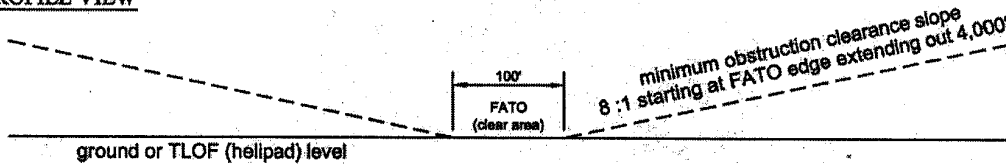

NOTE: The second approach / takeoff path may have a 5:1 slope if needed.

Section 14.APPENDIX G Heliport/Vertiport Standards

Section 14.ILLUSTRATION D Heliports Sample Obstruction Clearance Slope Calculations

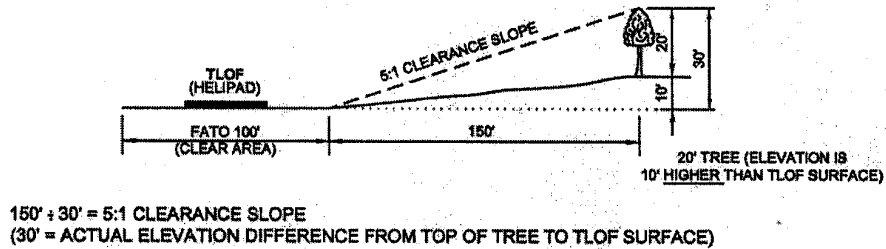
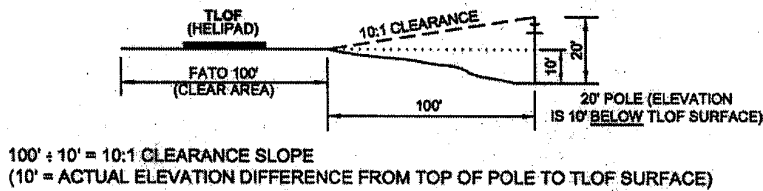
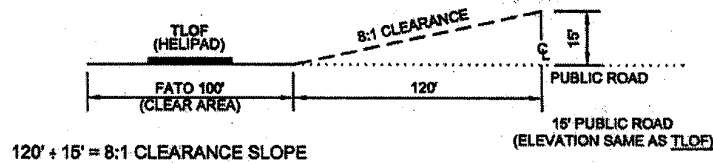

NOTE : 1. OBSTACLE CLEARANCE SLOPE IS CALCULATED ON DISTANCE OF OBSTACLE FROM THE FATO EDGE.

2. CLEARANCES REQUIRED FOR APPROACHES:

- 10' CLEARANCE OVER ALL PRIVATE ROADWAYS.
- 15' CLEARANCE OVER ALL PUBLIC HIGHWAYS.
- 17' CLEARANCE OVER ALL INTERSTATES.
- 23' CLEARANCE OVER ALL RAILROADS.

Section 14.APPENDIX G Heliport/Vertiport Standards**Section 14.ILLUSTRATION E Public or Private Heliport (Non-Hospital) Typical Heliport Marking**

NOTE: A HELIPORT WITHOUT A PAVED TLOF (HELIPAD) SHOULD HAVE THE FATO (CLEAR AREA) EDGES MARKED WITH FLUSH WHITE OR CONTRASTING COLOR IN-GROUND MARKERS AT EACH CORNER. THE FATO SHOULD BE MARKED WITH A WHITE OR CONTRASTING COLOR IN-GROUND "H" CENTERED IN THE FATO ALIGNED WITH THE PREFERRED APPROACH PATH TO THE HELIPORT. THE FATO EDGE MARKERS SHOULD BE NO LESS THAN 12" WIDE AND 5' IN LENGTH. THE "H" SHOULD BE NO LESS THAN 10' HIGH AND 6' WIDE.

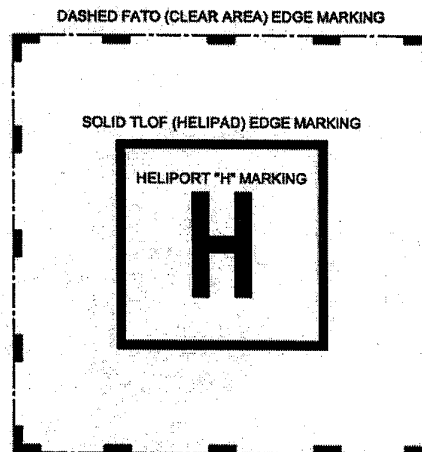

NOTE: A HELIPORT WITH A PAVED TLOF (HELIPAD) SHOULD HAVE A MINIMUM 10' "H" CENTERED ON THE PAD. IT IS SUGGESTED TO HAVE A WHITE OR CONTRASTING COLOR BORDER AROUND THE TLOF EDGE.

Section 14.APPENDIX G Heliport/Vertiport Standards

Section 14.ILLUSTRATION F Rooftop or Elevated Hospital Heliport Typical Heliport Marking

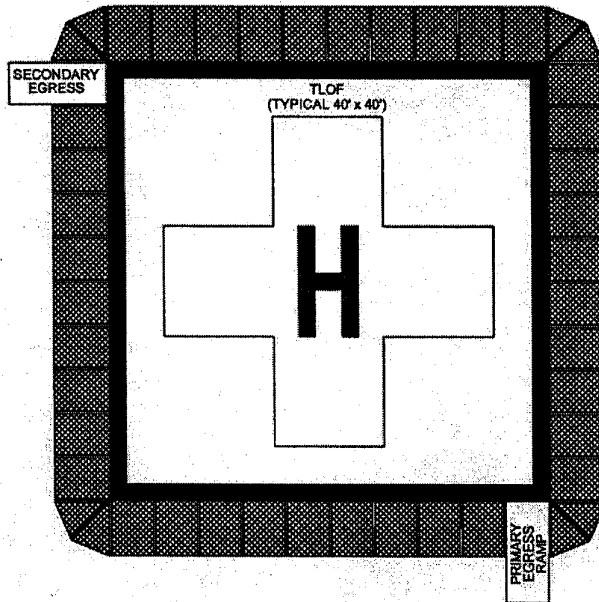

SIDE PROFILE VIEW

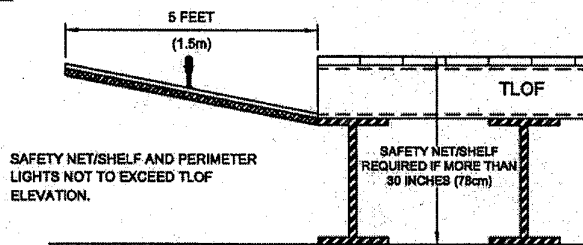

Section 14.APPENDIX G Heliport/Vertiport Standards

Section 14.ILLUSTRATION G Surface Hospital Heliport Typical Heliport Marking

PLAN VIEW

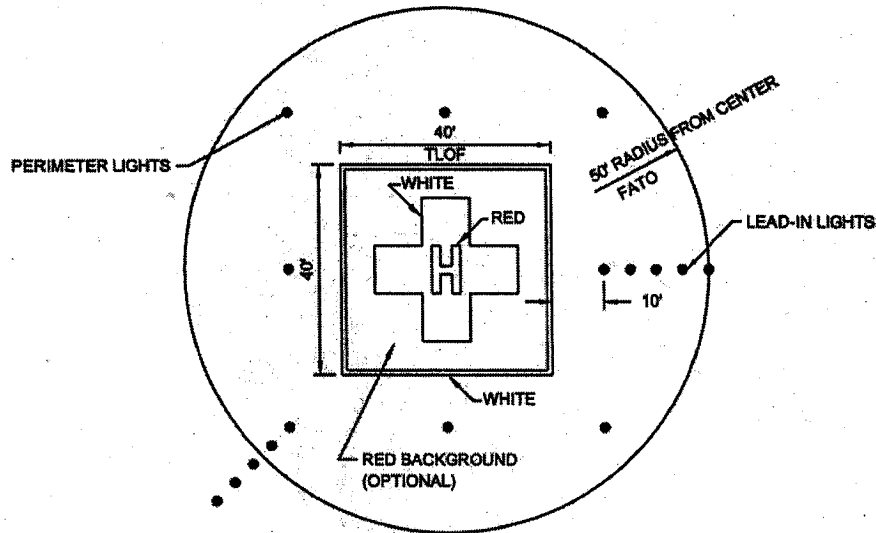

- NOTES:
1. 50' RADIUS FROM PAD CENTER TO BE CLEAR OF ALL OBJECTS HIGHER THAN TLOF ELEVATION.
 2. LEAD-IN LIGHTS SPACED APPROXIMATELY 5' APART BELOW TLOF LEVEL.
 3. HOSPITAL MARKING SCHEME:
 WHITE PERIMETER STRIPE - 12"
 RED BACKGROUND
 WHITE CROSS - 30' x 30'
 RED H - 10'

TLOF CROSS-SECTION

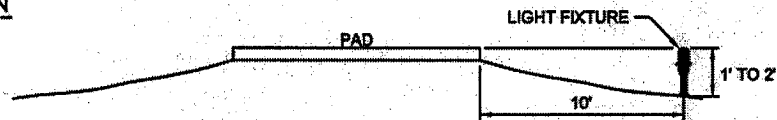

- NOTES:
1. TYPICAL SURFACE PAD 40' x 40' x 6" REINFORCED CONCRETE. EIGHT YELLOW PERIMETER LIGHTS, APPROACH LEAD-IN LIGHTS (RECOMMENDED).
 2. RECOMMEND BERMING PAD UP ONE TO TWO FEET. LIGHTS APPROXIMATELY 10' FROM PAD EDGE OFF SHOULDER NO HIGHER THAN PAD ELEVATION.

Section 14.APPENDIX H Heliport/Vertiport Standards, Facility Requirements and Restrictions on Use

Section 14.TABLE A Heliport Standards

Standard	Heliport/ Helistop Vertiport/ Vertistop Public-Use	Heliport/ Helistop Vertiport/ Vertistop Private-Use	Heliport/ Helistop Vertiport/ Vertistop Restricted Landing Area	Heliport/ Helistop Vertiport/ Vertistop Hospital
Minimum TLOF (Helipad) Size*	1 Rotor Diameter	1 Rotor Diameter	1 Rotor Diameter (Recommended)	1 Rotor Diameter (40' Minimum)
Minimum FATO (Clear Area) Size	2 x Rotor Diameter (100' Minimum)	2 x Rotor Diameter (100' Minimum)	2 x Rotor Diameter (100' Minimum)	2 x Rotor Diameter (100' Minimum)
Approach/ Departure Path Requirements	2 – 90° Apart Minimum (with 2:1 side transition) 8:1 Min. Slope	2 – 90° Apart Minimum (with 2:1 side transition) 8:1 Min. Slope	2 – 90° Apart Minimum 1 st Approach - 8:1 Min. Slope 2 nd Approach - may be 5:1 Min. Slope if necessary	2 – 90° Apart Minimum 1 st Approach - 8:1 Min. Slope 2 nd Approach - may be 5:1 Min. Slope if necessary

*NOTE: A 6" REINFORCED CONCRETE TLOF IS RECOMMENDED. If a concrete TLOF is not used, the FATO edges and center must be marked.

Section 14.APPENDIX H Helicopter/Vertiport Standards, Facility Requirements and Restrictions on Use**Section 14.TABLE B Facility Requirements**

Item	Helicopter/ Helistop Vertiport/ Vertistop Public-Use	Helicopter/ Helistop Vertiport/ Vertistop Private-Use	Helicopter/ Helistop Vertiport/ Vertistop Restricted Landing Area	Hospital Helicopter/ Helistop Vertiport/ Vertistop
24-Hour Phone	Required for helicopter only.	Not Required	Not Required	Not Required
Access Control a) Spectator b) Vehicular c) Perimeter	Required Required Required	Recommended Recommended Recommended	Recommended Recommended Recommended	Required Required Required Security and access may be controlled by hospital.
Fire Protection	Required for helicopters – one 20# extinguisher (two where fueling is present).	Required for helicopters – one 20# extinguisher (two where fueling is present).	Recommended	Required – one 20# extinguisher (two where fueling is present).
First-Aid Kit	Required for helicopter only.	Recommended for helicopter.	Not Required	Not Required
Fuel & Oil Sales	Required for helicopter during normal business hours. Available by phone after business hours.	Not Required	Not Required	Not Required
Hangar/Office	Required for helicopter only.	Not Required	Not Required	Not Required
Identification Beacons	Required for helicopters.	Recommended	Not Required	Recommended and required for all Trauma Centers.

Item	Heliport/ Helistop Vertiport/ Vertistop Public-Use	Heliport/ Helistop Vertiport/ Vertistop Private-Use	Heliport/ Helistop Vertiport/ Vertistop Restricted Landing Area	Hospital Heliport/ Helistop Vertiport/ Vertistop
Lead-in Lights and Arrows	Required for heliports.	Recommended	Not Required	Recommended
Marked FATO and/or TLOF Identifiable from 500' AGL	Required	Required	Required	Required
Paved TLOF	Recommended	Recommended	Not Required	Recommended
Perimeter/Flood Lighting	Required for night use.	Required for night use.	Recommended for night use.	Required for night use.
Potable Water	Required for heliport during normal business hours. Available by phone after business hours.	Not Required	Not Required	Not Required
Horizontal Safety Fence for Heliports Elevated 30" or Higher	Required	Required	Required	Required
Sanitary Restroom	Required for heliport during normal business hours. Available by phone after business hours.	Not Required	Not Required	Not Required
Wind Direction / Velocity Indicator (must be lighted for night use)	Required	Required	Required	Required

Section 14.APPENDIX H Helipport/Vertiport Standards, Facility Requirements and Restrictions on Use**Section 14.TABLE C Restrictions on Use**

Use	Helipport/ Helistop Vertiport / Vertistop Public-Use	Helipport/ Helistop Vertiport / Vertistop Private-Use	Helipport/ Helistop Vertiport / Vertistop Restricted Landing Area	Hospital Helipport/ Helistop Vertiport / Vertistop
Based Aircraft	No Restrictions	No Restrictions	Maximum of Six Based Helicopters.	Maximum of Six Based Helicopters.
Carrying of Passengers for Hire	Allowed	Allowed	Prohibited as Based Operation	EMS only
Commercial Maintenance	Allowed for heliports only	Allowed for heliports only	Prohibited	Prohibited
Flight Instruction	Unrestricted	Unrestricted	a) Restricted to immediate family of Certificate Holder (excluding cert. held by corp.). Non-continuous. b) Specialized dual instruction originating from a bonafide flight training operation based at a heliport.	Prohibited
Through-the-Fence Operations	Allowed	Not Applicable	Not Applicable	Not Applicable
Agricultural Operations	Allowed	Allowed	Allowed	Not Applicable
Application of De-icing Agents	Only non-corrosive de-icing agents allowed.	Only non-corrosive de-icing agents allowed.	Only non-corrosive de-icing agents allowed.	Only non-corrosive de-icing agents allowed.

